

**VITO**  
AGRO



**MULTISTAGE  
SUBMERSIBLE  
WATER PUMP FOR  
CLEAN WATER**

THE PORTUGUESE  
1988  
LEADER  
OF THE PACK



VIBSMAL1000

## MULTISTAGE SUBMERSIBLE WATER PUMP FOR CLEAN WATER

VITO AGRO multistage submersible water pump is a compact and robust device designed for domestic water supply. The multistage submersible water pump has 1000 watts of power and pumps up to 6500 L/h of clean water with particles up to 1 mm in size. Thanks to its high capacity for suction water in height (up to 40 meters), this water pump ensures increased efficiency and power.

This practical and easy to use VITO AGRO multistage submersible water pump ensures high quality performance in water transfer and supply.

### Main features:

- > Stainless steel pump body;
- > Height-adjustable float switch turns the pump on or off automatically depending on the water level

### Technical data:

Power	1000W
Supply voltage	230V AC 50Hz
Minimum immersion depth	50 mm
Maximum immersion depth	7 m
Maximum manometric height	40 m
Maximum flow rate	6500 L / h
Threads	1"
Maximum particle size	1 mm
Power cord length	10 m
Maximum liquid temperature	35°C
IP code	IPX8
Weight	9,5 kg
Dimensions	150(A) x 440(B) x 150(C) mm
Weight with packaging	10,125 kg
Packaging dimensions	220x200x500mm
EAN code	5604612710439



↑ 40 m  
max.

↓ 7 m  
max.

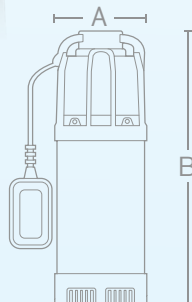

# BSMAL 1000W

**Manometric chart:**

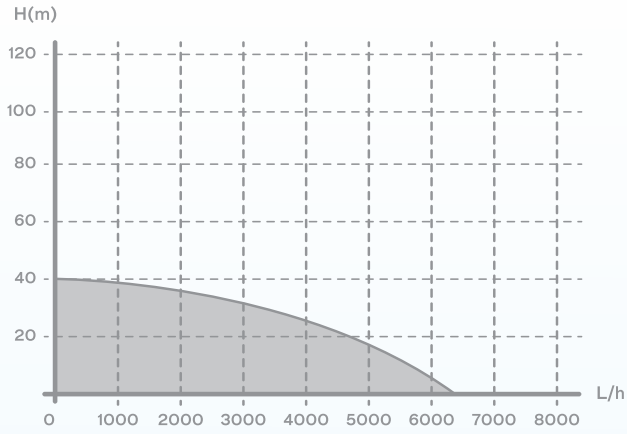



vito-tools.com



 **VITO**  
AGRO

**DIESEL TILLER  
WITH DIRECT  
TRANSMISSION  
12 hp**





## VIMEDTD12A

### 12hp DIESEL TILLER WITH DIRECT TRANSMISSION

The VITO's robust and powerful tiller has been designed to work in a comfortable and agile way, achieving maximum quality in the soil. Its 456cc diesel engine with an output power of 12hp/8.9kW is fitted with a 2-speed gearbox (2 forward + 1 reverse) for maximum performance.

The appliance includes a double furrow opener, 360mm diameter tines.

It has a working width of 1450mm being suitable medium or large-sized terrains.

This environmental friendly and Euro V compliant appliance is ideal for those looking for quality and performance.



**12 CV**  
MEDTD12A 456CC  
**DIESEL**

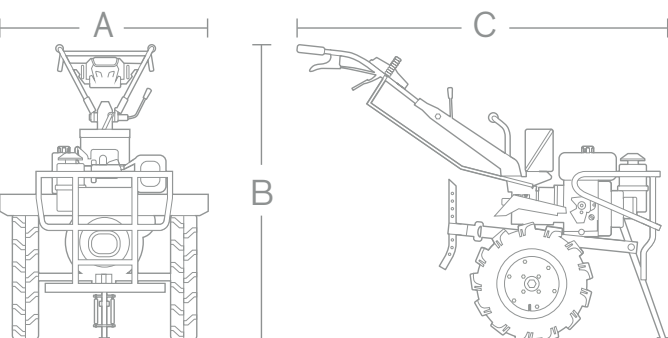

#### Main features:

- > Battery for electric start;
- > Tool box.

#### Technical data:

Engine:	Diesel
Power:	12 hp / 8.9 kW
Displacement:	456 cc
Rotation speed:	3600 r.p.m.
Drive:	Direct
Speeds:	2 forward + 1 reverse
Fuel:	Diesel
Fuel tank capacity:	5,5 L
Operating width:	1450 mm
Tine's diameter:	360 mm
Engine oil:	15W40
Engine oil sump capacity:	1,65 L
Gearbox oil sump capacity:	2,5L
Product weight:	180 kg
Product dimensions:	1450(A) x 1400 (B) x 1750(C) mm
Weight with packaging:	194 kg
Packaging dimensions:	1010 x 650 x 820 mm
EAN code:	5604612712181



**Tool box**



**Gear shift lever**

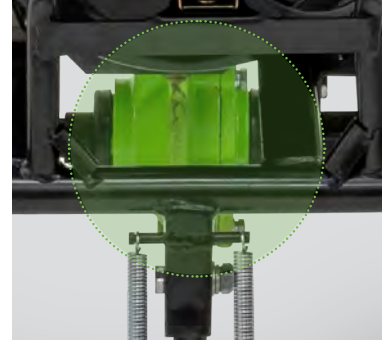

**Gearbox**



**Fuel tank**

The engine runs on **diesel**.

**Never use contaminated diesel or other type of fuel. Avoid dirt or water in the fuel tank.**

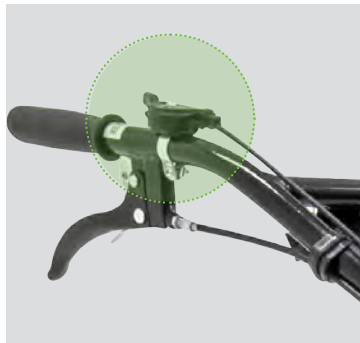

**Throttle lever**

The throttle lever allows you to adjust the rotation speed of the combustion engine.

Turn the lever to the desired speed. On the left, it is in the stop position; on the right it is at full speed.

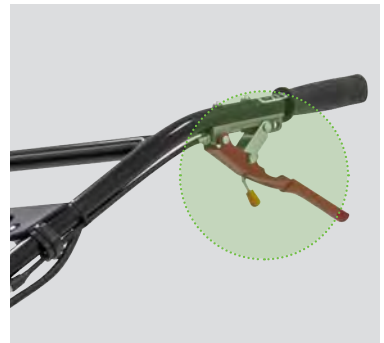

**Clutch lever**



**Packaging content:**

- |                                       |  |   |
|---------------------------------------|--|---|
| > x1 - Tiller                         | > x2 - Tines' side disc  | > x1 - Gear shift lever                                     |
| > x1 - Handlebar                      | > x1 - Furrow opener and fixing accessory                          | > x1 - Drive engagement cable                               |
| > x2 - Fender guard                   | > x1 - Depth gauge fixing accessory                                | > x1 - Front grille guard                                   |
| > x1 - Fender guard rear support bar  | > x1 - Automatic start system, connection cables and ignition keys | > x1 - Key set  |
| > x2 - Fender guard side support bars | > x1 - Battery bracket   | > x1 - Rubber sheet for battery bracket                     |
| > x1 - Air filter                     | > x1 - Battery   | > x2 - Cable ties   |
| > x2 - Drive wheels                   | > x2 - Cables with terminals                                       | > x1 - Set of bolts, nuts, washers, clevis pins and R-clips |
| > x2 - Drive wheel shaft              | > x1 - Handlebar rod   |   |
| > x1 - Tines set                      | > x1 - Tool box  |   |



## Accessories for 12hp Diesel tiller with direct transmission

Vito has several accessories at your disposal that you can purchase separately, either for the loss, wear or breakage of the accessory in question.

### Furrow opener

	Ref <sup>a</sup> :	Designation		EAN CODE
	VIMEDTD12AARD	Double furrow opener	1	5604612714314

### Trailer

	Ref <sup>a</sup> :	Designation		EAN CODE
	VIAME12	Trailer for tiller	1	5604612689957



### VITR2500

## Garden Shredder

The VITO's Garden Shredder (TR2500) makes it possible to shred branches resulting from pruning, gardening tasks and other organic materials, allowing them to be reused and recycled as compost or to reduce the volume of waste. The appliance features a 2500W and 4500rpm motor and a collection box with a maximum capacity of 45 litres.

It is practical and easy to transport thanks to its wheels and efficient thanks to its manual push stick.



## TR2500

### MAIN FEATURES:

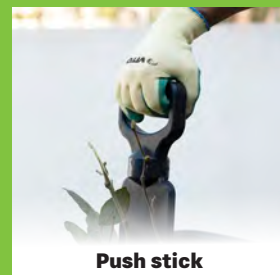

Push stick



ON/OFF switch



Collection box 45L



Transport wheels

### Technical data:

Rated power:	2500 W
Power supply:	230 V AC 50 Hz
Motor type:	Carbon brushes
No-load speed:	4500 r.p.m.
Maximum branch diameter:	Ø 45 mm
Collection box capacity:	45L
IP rating:	IP24
Vibration level:	< 2,5m/s <sup>2</sup>
Sound power level (L <sub>WA</sub> ):	106 dB
Sound pressure level (L <sub>PA</sub> ):	94.7 dB
Insulation class:	II
Product weight:	12 kg
Product dimensions:	545 (A) x 1015 (B) x 444 (C) mm
Weight with packaging:	13,4 kg
Packaging dimensions:	530 x 370 x 510 mm
EAN Code:	5604612709730

### Packaging content:

1x	Garden shredder
1x	Collection box
2x	Wheels
2x	Wheel caps
2x	Supporting bars
1x	Axle
1x	Push stick
1x	Set of nuts, washers and bolts
1x	Instruction manual

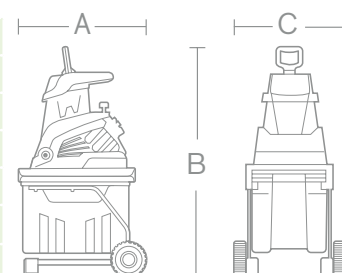

 **VITO** AGRO

# NEW RANGE *MAGNUM* CHAINSAWS





## NEW RANGE CHAINSAWS

The VITO AGRO range of chainsaws is designed to perform the most demanding tasks such as tree felling, logs cutting and pruning.

These easy-to-use chainsaws are equipped with a 2-stroke engine and a powerful, robust and quality Walbro carburetor.

The high-quality Oregon saw chain and guide bar are suitable for quality and accurate cutting.

This reliable and long-lasting appliance has an air flow system for better engine cooling engine and reduction of emissions.

These chainsaws are also equipped with a Champion spark plug that is fundamental in the combustion process. They stand out for their cutting capacity and high power, thus ensuring fast and efficient results

## VIMS37 CHAINSAW

37cc

### MAGNUM R37



#### Main features

- > Easy oil flow adjustment;
- > Anti-vibration and soft grip handle;
- > Oregon guide bar;
- > Walbro carburetor primer bulb.

#### Technical data

Engine:	Combustion - 2 Stroke
Cubic centimeters:	37 cc
Power:	2,1 Hp   1,55 kW
Rotation speed:	12.000 rpm
Fuel:	Mixture - 1:40 ratio
Fuel tank capacity:	0,55 L
Drive links:	57
Chain pitch:	3/8"
Guide bar length:	400 mm
Chain oil:	260 ml
Sound pressure level (L <sub>PA</sub> ):	98,3 dB
Sound power level (L <sub>WA</sub> ):	110,9 dB
Weight:	6,3 kg
Dimensions:	790 (A) x 245 (B) x 275 (C) mm
Packaging weight:	7,425 kg
Packaging dimensions:	440 x 275 x 310 mm
EAN code:	5604612708580

#### Packaging content

- > Chainsaw;
- > Saw chain;
- > Guide bar;
- > Guide bar cover
- > Spark plug wrench
- > File

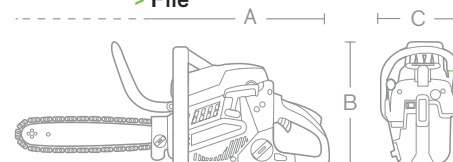

# VIMS45B CHAINSAW

45cc

# VIMS55 CHAINSAW

55cc



### Main features

- > Easy oil flow adjustment;
- > Anti-vibration and soft grip handle;
- > Oregon guide bar;
- > Walbro carburetor primer bulb.

### Technical data

Engine:	Combustion - 2 Stroke
Cubic centimeters:	45 cc
Power:	2,5 Hp   1,95 kW
Rotation speed:	12.000 rpm
Fuel:	Mixture - 1:40 ratio
Fuel tank capacity:	0,52 L
Drive links:	72
Chain pitch:	0,325"
Guide bar length:	450 mm
Chain oil:	250 ml
Sound pressure level (L <sub>PA</sub> ):	101,8 dB
Sound power level (L <sub>WA</sub> ):	109,3 dB
Weight:	7,4 kg
Dimensions:	890 (A) x 295 (B) x 245 (C) mm
Packaging weight:	8,630 kg
Packaging dimensions:	470 x 277 x 312 mm
EAN code:	5604612708597

### Packaging content

- > Chainsaw;
- > Saw chain;
- > Guide bar;
- > Guide bar cover
- > Spark plug wrench
- > File



### Main features

- > Easy oil flow adjustment;
- > Anti-vibration and soft grip handle;
- > Oregon guide bar;
- > Walbro carburetor primer bulb.

### Technical data

Engine:	Combustion - 2 Stroke
Cubic centimeters:	55 cc
Power:	3,2 Hp   2,4 kW
Rotation speed:	12.000 rpm
Fuel:	Mixture - 1:40 ratio
Fuel tank capacity:	0,52 L
Drive links:	78
Chain pitch:	0,325"
Guide bar length:	500 mm
Chain oil:	250 ml
Sound pressure level (L <sub>PA</sub> ):	102,7 dB
Sound power level (L <sub>WA</sub> ):	110,5 dB
Weight:	7,4 kg
Dimensions:	890 (A) x 300 (B) x 245 (C) mm
Packaging weight:	9,010 kg
Packaging dimensions:	530 x 278 x 320 mm
EAN code:	5604612708603

### Packaging content

- > Chainsaw;
- > Saw chain;
- > Guide bar;
- > Guide bar cover
- > Spark plug wrench
- > File

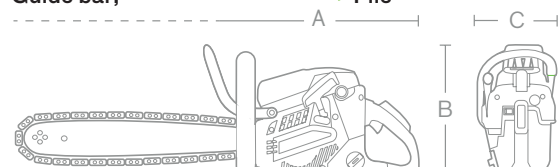

# OVERVIEW CHAINSAWS



Ref. <sup>a</sup>	VIMS37	VIMS45B	VIMS55
Engine:	Combustão 2T	Combustão 2T	Combustão 2T
Cubic centimeters:	37cc	45cc	55cc
Power:	2,1 Hp   1,55 kW	2,5 Hp   1,95 kW	3,2 Hp   2,4 kW
Rotation speed :	12.000 rpm	12.000 rpm	12.000 rpm
Fuel:	Mixture - 1:40 ratio	Mixture - 1:40 ratio	Mixture - 1:40 ratio
Fuel tank capacity:	0,55 L	0,52 L	0,52 L
Guide bar length:	400 mm	450 mm	500 mm
Drive links:	57	72	78
Chain pitch:	3/8"	0,325"	0,325"
Chain oil:	260 ml	250 ml	250 ml
Sound power level (L <sub>WA</sub> ):	110,9 dB	109,3 dB	110,5 dB
Weight:	6,3 kg	7,4 kg	7,4 kg
Dimensions:	790 x 245 x 275 mm	890 x 295 x 245 mm	890 x 300 x 245 mm

## Conteúdo da embalagem:

Chain oregon:	✓	✓	✓
Guide bar oregon:	✓	✓	✓
Guide bar cover:	✓	✓	✓
Assembly keys:	✓	✓	✓
Packaging weight:	7,425 kg	8,630 kg	9,010 kg
Packaging dimensions:	440 x 275 x 310 mm	470 x 277 x 312 mm	530 x 278 x 320 mm

**NEW**

**PRUNING CHAINSAW**  
AGRICULTURAL MACHINERY AND EQUIPMENT



The VITO pruning chainsaw is the perfect tool for pruning as well as removing branches, leaves or twigs and preserving the green spaces.

This high-quality appliance is equipped with Oregon chain guide bar and Walbro carburetor to cut precisely and efficiently. It also features a built-in easy-start system, automatic brake and anti-vibration function to absorb impacts.

Its ergonomic handle ensures greater comfort and safety for its users. Thanks to its durability, the pruning chainsaw is the ideal partner to carry out your work with greater quality and precision.

**VIMP2810**  
**PRUNING CHAINSAW**

**28,5cc**



**MAGNUM**  
**R28**



**Main features**

- > Chain tension adjustment;
- > Anti-vibration and soft grip handle;
- > OREGON guide bar;

**Technical data**

Engine:	Combustion - 2 Stroke
Power:	1,3 cv   1 kW
Cubic centimeters:	28,5 cc
Rotation speed:	12.000 rpm
Fuel:	Mixture - 1:40 ratio
Fuel tank capacity:	0,21 L
Drive links:	40
Chain pitch:	3/8"
Guide bar length :	250 mm
Chain oil:	200 ml
Sound pressure level (L <sub>PA</sub> ):	97,2 dB
Sound power level (L <sub>WA</sub> ):	109,3 dB
Weight:	3,9 kg
Product dimensions:	540 x 240 x 232 mm
Packaging dimensions:	300 x 260 x 260 mm

**Packaging content**

- > Pruning chain saw
- > Guide bar cover
- > Saw chain
- > Spark plug wrench
- > Guide bar
- > File

REF<sup>a</sup>



EAN.

**VIMP2810**

1

5604612708573



# VITO

GARDEN

# GARDEN KITS



MADE IN  
PORTUGAL



Each tool is shaped with precision and care until it gets the desired form. The quality that distinguishes us is the proof of the daily work and effort present in each piece and represents the beginning of a new age: VITO Hand Tools for gardening and agricultural work. Since 1988 we have been producing in Portugal, quality pieces that stand out for their uniqueness, reliability and durability of their materials to make work easier with high performance. Each tool symbolises the persistence and excellence with which we work every day to offer the best hand tools to our consumers.



kit 3 



3 PIECES GARDEN TOOL SET IN STEEL

REF <sup>a</sup>		EAN.
<b>VIKJ3C</b>	1	5604612714048

- The kit includes:
- > Transplanting trowel;
  - > 2-tine small double hoe;
  - > 5-teeth hand rake.

- > Made of S235 JR carbon steel with thermosetting powder coating;
- > Beechwood handle with a water-based pore filler finish.



kit 6 



6 PIECES GARDEN TOOL SET IN STEEL

REF <sup>a</sup>		EAN.
<b>VIKJ6C</b>	1	5604612714055

- The kit includes:
- > Pointed garden hoe;
  - > Small double-hoe;
  - > Weeding knife;
  - > 3-teeth cultivator;
  - > Transplanting trowel;
  - > 3-teeth hand rake.

- > Made of S235 JR carbon steel with thermosetting powder coating;
- > Beechwood handle with a water-based pore filler finish.



# VITO

## GARDEN



### NEW

## HOSE + IRRIGATION KIT - 5 PIECES

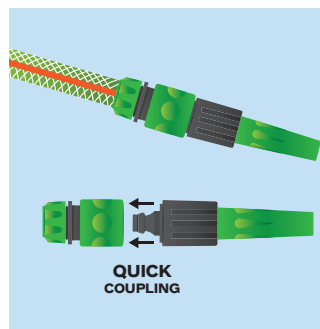
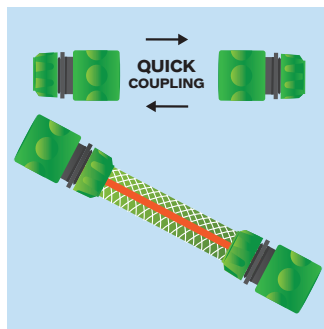
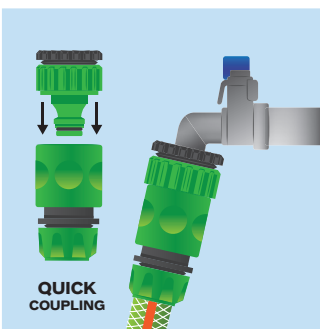

### Ideal for:

- > Garden;
- > Water transport;
- > Domestic use.

### Hose material:

- > Flexible PVC, with 3 layers, one with polyester braid reinforcement.

	REF <sup>a</sup>	Ø	A	Bar		EAN.
<b>NEW</b>	<b>VIK1215</b>	12 mm   1/2"mm	15m	17	1	5604612712471
	<b>VIK6010</b>	15 mm   5/8"mm	10m	20	1	5604612011079
	<b>VIK6015</b>	15 mm   5/8"mm	15m	20	1	5604612011086
	<b>VIK6020</b>	15 mm   5/8"mm	20m	20	1	5604612011093
	<b>VIK1915</b>	19 mm   3/4"mm	15m	20	1	5604612644574
	<b>VIK1925</b>	19 mm   3/4"mm	25m	20	1	5604612644581



**NEW**

# FRUIT PICKER

AGRO HAND TOOLS



**Features:**

- Used to harvest different types of fruit (fruit farming);
- Material: carbon steel;
- It includes “hooks” that make easier fruit picking;
- The hand tool also features a sponge pad to avoid fruit damage.

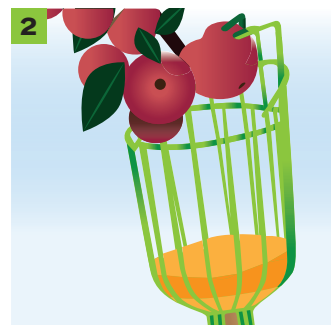
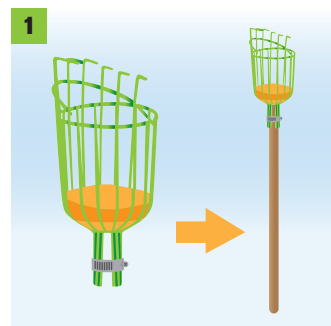

REF<sup>a</sup>

AxB



EAN.

**VIAFA**

325x145 mm

1

5604612703929

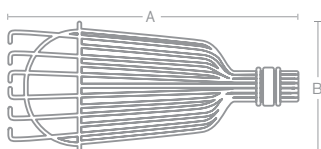

# VITO GARDEN

## NEW HAND TOOLS

AGRO- GARDEN

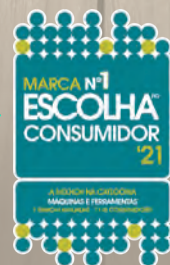

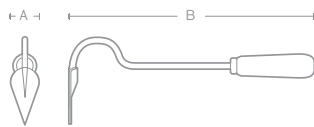

### POINTED GARDEN HOE

REF <sup>a</sup>	AxB			EAN.
<b>VIBJMS</b>	55x315mm	271g	12	5604612710699

- > Made of S235 JR carbon steel S235 JR with thermosetting powder coating;
- > Beechwood handle with a water-based pore filler finish.

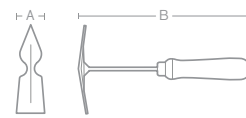

### POINTED AND FLAT DOUBLE HOE

REF <sup>a</sup>	AxB			EAN.
<b>VIspbms</b>	55x250mm	205g	12	5604612710637

- > Made of S235 JR carbon steel S235 JR with thermosetting powder coating;
- > Beechwood handle with a water-based pore filler finish.

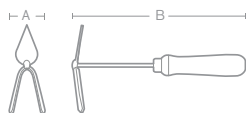

### 2-TINE SMALL DOUBLE HOE

REF <sup>a</sup>	AxB			EAN.
<b>VIspqms</b>	75x250mm	200g	12	5604612710644

- > Made of S235 JR carbon steel S235 JR with thermosetting powder coating;
- > Beechwood handle with a water-based pore filler finish.

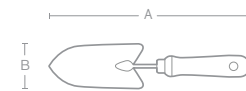

### TRANSPLANTING TROWEL

REF <sup>a</sup>	DIM.	AxB			EAN.
<b>VIPTpms</b>	Small	280x75mm	220g	12	5604612710613
<b>VIPTgms</b>	big	310x95mm	300g	12	5604612710682

- > Made of S235 JR carbon steel S235 JR with thermosetting powder coating;
- > Beechwood handle with a water-based pore filler finish.

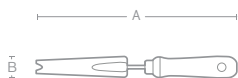

### WEEDING KNIFE

REF <sup>a</sup>	AxB			EAN.
<b>VIAREMS</b>	325x40mm	185g	12	5604612710668

- > Made of S235 JR carbon steel S235 JR with thermosetting powder coating;
- > Beechwood handle with a water-based pore filler finish.

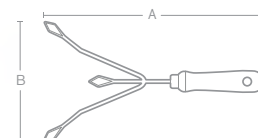

### 3-TINE CULTIVATOR

REF <sup>a</sup>	AxB			EAN.	
<b>VIA3DMS</b>	300x85mm	3	218 g	12	5604612710620

- > Made of S235 JR carbon steel S235 JR with thermosetting powder coating;
- > Beechwood handle with a water-based pore filler finish.

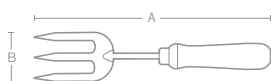

### 3-TINE HAND RAKE

REF <sup>a</sup>	AxB			EAN.	
<b>VIA3DMS</b>	310x85mm	3	240g	12	5604612710651

- > Made of S235 JR carbon steel S235 JR with thermosetting powder coating;
- > Beechwood handle with a water-based pore filler finish.



### 5-TINE HAND RAKE

REF <sup>a</sup>	A			EAN.	
<b>VIA5DMS</b>	90x240 mm	5	210g	12	5604612710675

- > Made of S235 JR carbon steel S235 JR with thermosetting powder coating;
- > Beechwood handle with a water-based pore filler finish.

**NEW**

# GARDEN SCRAPER

AGRO HAND TOOLS – GARDEN

The VITO Garden Scraper is a quality hand tool designed for professionals who stand for organic farming, without the use of chemicals for removing lawn, roadside and patios weeds, as well as soil crusting.



CK47 steel band saw blade  
(impact and wear-resistant)



Steel head  
S275JR

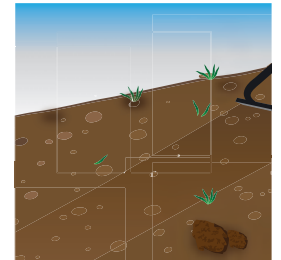
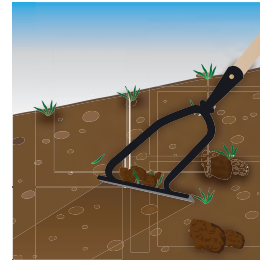
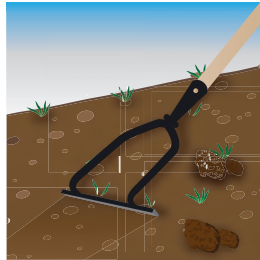

REF<sup>a</sup>

AxB



EAN.

**VIRPJ**

1790x160mm

VI4010

6

5604612709150

