

VITO

PRO POWER

**1500W
SLIDING MITRE
SAW**



VITO PRO-POWER sliding mitre saw is the ideal solution for cutting.

This appliance has 1500 watts of power and a rotation speed of 5000 rpm, ensuring great accuracy and reliable cuts.

It is equipped with a 210 mm diameter blade, which ensures high cutting capacity, and laser guide for more efficient and accurate cuts.

It performs angled cuts of 45° and - 45° reaching a depth of up to 210 mm, always ensuring maximum versatility and accuracy.

Robust and compact, this sliding mitre saw is the right choice for tasks that require total accuracy.



VISCME210 1500W - 210 mm sliding mitre saw



Technical data:

Power:	1500W
Supply voltage:	230V AC 50Hz
No-load speed:	5000 r.p.m.
Blade diameter:	210 mm
Blade hole diameter:	30 mm
Blade thickness:	2,8 mm
Number of teeth:	24
Cutting angle (miter cut 0°)	
> Bevel 0°	310 x 60
> Bevel 45	310 x 36
Cutting angle (miter cut 45°)	
> Bevel 0°	210 x 60
> Bevel 45°	210 x 36
Sound power level (L _{WA}):	107 dB
Sound pressure level (L _{PA}):	94 db
Insulation class:	II
Weight:	11 kg
Dimensions:	655(A) x 930(B) x 500(C)mm
Weight with packaging:	13,4 kg
Packaging dimensions:	725 x 455 x 365mm
EAN code:	5604612712716

Packaging content:

1x	Sliding miter saw VISCME210
1x	210 mm Wood cutting saw blade
2x	Hex keys
1x	Dust and shavings collection bag
1x	Clamp
1x	Miter locking handle
2x	Plastic side support
1x	Set of carbon brushes
1x	Set of washers for saw blade

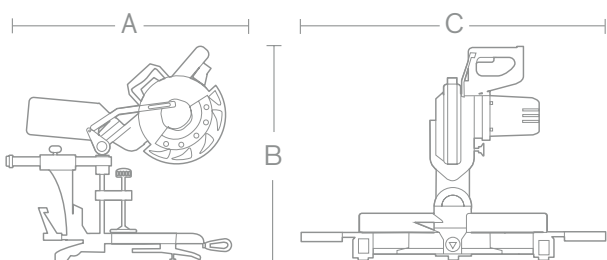



Double slide rail

Allows the cutting head to be moved along the workpieces, allowing to make larger cuts.



Adjustable turntable from -45° a $+45^\circ$



Bevel cut at 45° to both sides

Indicates the selected angle on the scale placed on the slide rail support.



Dust and shavings collection bag



Fixing clamp



Carrying handle



Laser guide



ensures that you cut the workpiece with the desired orientation.

Accessories for sliding mitre saw

Vito has several accessories at your disposal that you can purchase separately, either for the loss, wear or breakage of the accessory in question.

> Tungsten carbide tipped blade



Ref:	Number of teeth	Outer diameter	Inner hole	Thickness		EAN CODE
	VIDC210	24	Ø210 mm	Ø30 mm	1,6 mm	6 5604612670801

Individual protection

Vito offers you equipment that you can purchase separately to ensure your protection and safety when performing your professional tasks.



> 3PCS SET PARTICULATE RESPIRATORS WITH VALVE FFP1



Ref:		EAN CODE
	VIC821VP1	6 5604612700898



> ADJUSTABLE EAR MUFF



Ref:		EAN CODE
	VIP1340	10 5604612024963

> ULTRA-THIN PU-COATED GLOVE



Ref:	SIZE		EAN CODE
	VILU8 8" - M		5604612640149
	VILU9 9" - L	12	5604612640460
	VILU10 10" - XL		5604612640477

VILALC20V

20 MT GREEN SELF-LEVELLING CROSS-LINE LASER

VITO's self-levelling cross-line laser projects 2 green light lines, one horizontal and one vertical, which can be used simultaneously or alternated independently.

Equipped with a Class 2<1mw laser, it features a working range of 20 meters and an accuracy of +/- 0.5mm/m.

This appliance is intended for levelling interior and exterior surfaces such as walls, floors and ceilings, among others.

In addition, it is powered with 2 1.5 (AA) rechargeable batteries with a 3-hour autonomy and has a 1/4" tripod fixing thread.



EASY TO USE

Technical data:

Voltage:	3 V
Battery type:	2 x 1,5V LR06 (AA)
Autonomy:	> 3 h
Laser wavelength:	510 ~520 nm
Laser output power:	Class 2, < 1 mW
Laser line width:	100 lux, 3mm/ 5m
Working range:	20m
Accuracy:	± 0.5 mm / m
Levelling time:	< 5 s
Levelling range:	4°
Tripod thread:	1/4"
Operating temperature:	0° ~ 40°C
Weight:	0,28 kg
Dimensions:	55(A) x 85 (B) x 71 (C)mm
Weight with packaging:	0,43 kg
Packaging dimensions:	121 x 178 x 63mm
EAN code:	5604612712839

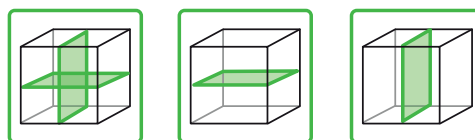
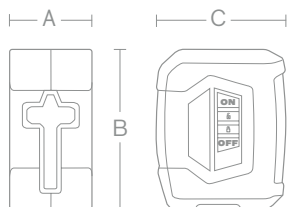

Packaging content:

1x	Laser VILALC20V
2x	Alkaline batteries 1.5V LR06(AA)



Laser beam outlet

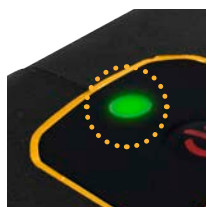

Self-levelling LED indicator

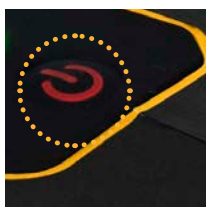

Laser line selector button



VILAPHVT20V

3X360° GREEN SELF-LEVELLING CROSS-LINE LASER

VITO's 3X360° self-levelling cross-line laser projects 3 green light lines in 360°, horizontal, vertical and side one, which can be used simultaneously or alternated independently. Equipped with a Class 2<1mw laser, it features a working range of 20 meters and an accuracy of +/- 0.5mm/m.

This appliance is intended for levelling interior and exterior surfaces such as walls, floors and ceilings, among others.

In addition, it is powered by 4 LR06 (AA) 1.5 V alkaline batteries with a 3-hour autonomy and has a 1/4" tripod fixing thread.



Technical data:

Voltage:	6 V
Battery type:	4 x 1,5V LR06 (AA)
Autonomy:	3 h
Laser wavelength:	510 ~520 nm
Laser output power:	Class 2, < 1 mW
Laser line width:	100 lux, 3mm/ 5m
Working range:	20 m
Accuracy:	± 0.5 mm / m
Levelling time:	< 4 s
Levelling range:	4°
Tripod thread:	1/4"
Operating temperature:	0° ~ 40°C
Weight:	0,5 kg
Dimensions:	85(A) x 110(B) x 110(C)mm
Weight with packaging:	1,1 kg
Packaging dimensions:	176 x 124 x 150mm
EAN code:	5604612712846

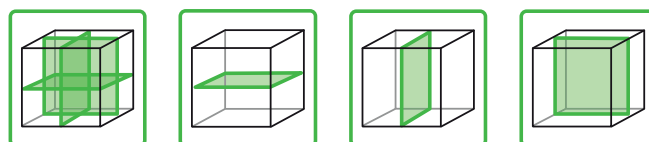
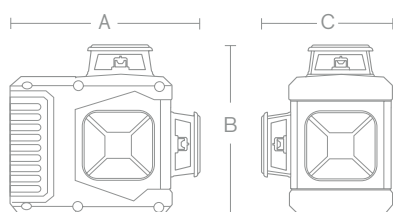

Packaging content:

1x	Laser VILAPHVT20V
4x	Alkaline batteries 1.5V LR06 (AA)



Vertical laser beam outlet



Horizontal laser beam outlet



Transversal laser beam outlet

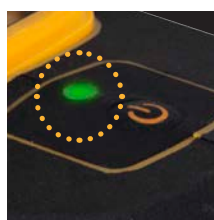

Self-levelling LED indicator





VISLA LASER BASE

VITO's magnetic base allows simple and quick fixing of the laser level, suitable for 1/4" threads. It can be rotated 360° which makes it easy to adjust the laser level and it is also possible to adjust the height and angle in the safest and most precise way.

Technical data:

Thread:	1/4"
Base:	Magnetic
Rotating base:	360°
Adjustable in:	Height and angle
Dimensions:	85(A) x 125(B) x 130(C)mm
Weight:	0,21 kg
Weight with packaging:	0,27 kg
Packaging dimensions:	128 x 139 x 86,8mm
EAN code:	5604612715076

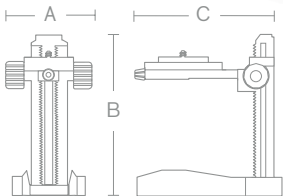

Packaging content:

1x	Laser Base
----	------------



Magnetic



Table mounting

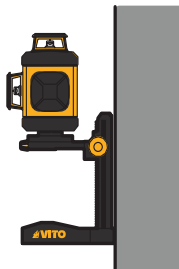

Wall mounting

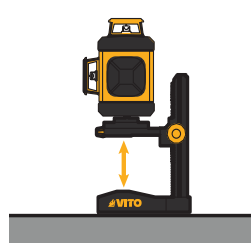

Adjustable height



Adjustable angle

VITO

PRO POWER



1400W ASH VACUUM CLEANER & BLOWER

 **TORNADO**
1400W HEPA FILTER 

THE PORTUGUESE
1988
LEADER
OF THE PACK



VIASC18T
1400W ASH VACUUM
CLEANER & BLOWER

Main features:

- > Metal tank;
- > Extra function - Blower;
- > Easy emptying of the tank through the side metal latch;
- > Power cord holder for better storage;
- > Ideal for cleaning fireplaces, barbecues, wood stoves, pellets etc.;

Technical data:

Rated power:	1400 W
Power supply voltage:	230 V AC 50Hz
Suction power:	18 kPa
Airflow:	1,7m ³ /min
Tank capacity:	18 L
Suction hose:	1 m
Suction tubes:	200 mm
Power cord:	1,5m
Filter:	HEPA
Sound power level:	76 dB
Dimensions:	290(A)x370(B)x293(C)mm
Weight:	3,18 kg
Packaging dimensions:	310x310x390 mm
Weight with packaging:	3,83 kg
Insulation class:	II
EAN code:	5604612713010



Washable particle
HEPA filter

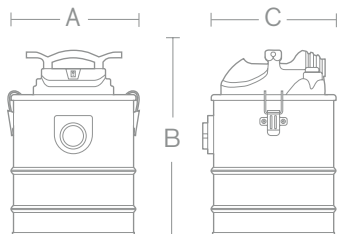

Packaging content

- > Ash vacuum cleaner
- > Suction tube
- > Suction hose
- > Filtro HEPA

FUNCTIONS:



> Vacuuming



> Blowing



HEPA FILTER CLEANING:



DUST STIRRER SWITCH:



STORAGE:





Watch video:

 **VITO**
PRO POWER
vito-tools.com



The VITCRC coaxial and network cable tester has been designed for network cables maintenance and cable testing, enabling a quick check of RJ45 connectors on broadband networks and BNC coaxial cables.

The following cables can be tested:

- EIA/TIA 568A/568B RJ45 cable;
- BNC (10 Base-T) cable;
- 100Base-TX, 1000-Base-Tx cables;
- Token Ring, AT&T258A, coaxial cable

Features:

- Visible LED indicators;
- Compatible connectors: RJ45 and BNC;
- Compatible cables: twisted-pair and coaxial;
- Powered by 9V alkaline battery (not included).



COAXIAL AND NETWORK CABLE TESTER

REF ^a		EAN.
VITCRC	1	5604612712198



BNC





WELDING ELECTRODE RUTILE

ACCESSORIES AND CONSUMABLES



Electrodes to add
to the existing range.

FEATURES:

Current type

AC/DC+

Classification

AWS A5.1:E6013
EN ISO 2560-A-E 42 A RC 11

Chemical classification(%)

C 0,07 | Si 0,35
Mn 0,35 | P 0,02 | S 0,02

Mechanical properties

Yield strength (N\mm²) > 450
Tensile strength (N\mm²) > 500
Elongation 5d (%) > 22

Materials/ Area of application

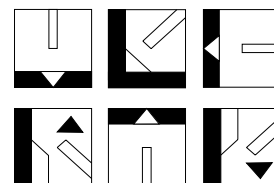

St 33 to St 52.3
St 35.8 to St 45.8
HI - HII | StE 210.7 to StE 360.7
St 37.4 to St 52.4
StE 210.7 TM to StE 360.7 TM
A, B | GS-38 to GS-52

Welding positions



Coating:

Rutile-cellulose, for universal use
in carbon steel welding.
Easy creation and recreation of
the welding arc.

REF.	Ø	Dim.	Current intensity	Current type (+ pole)			EAN Code
VIER20	2,0mm		50-70A		1188	396	5604612711597
VIER25	2,5mm	350 mm	60-90A	AC/DC+	795	265	5604612711603
VIER32	3,2mm		528		176	5604612711610	
VIER40	4mm		330		110	5604612711627	



VITO

HAND TOOLS



**PRECISION S2
BITS WITH DRIVER**



VITO



THE PORTUGUESE
1988
LEADER
OF THE PACK

Set of 24 S2 steel precision Bits with screwdriver to tighten and loosen with quality and accuracy. This practical, durable and portable kit is a great option for everyday use.

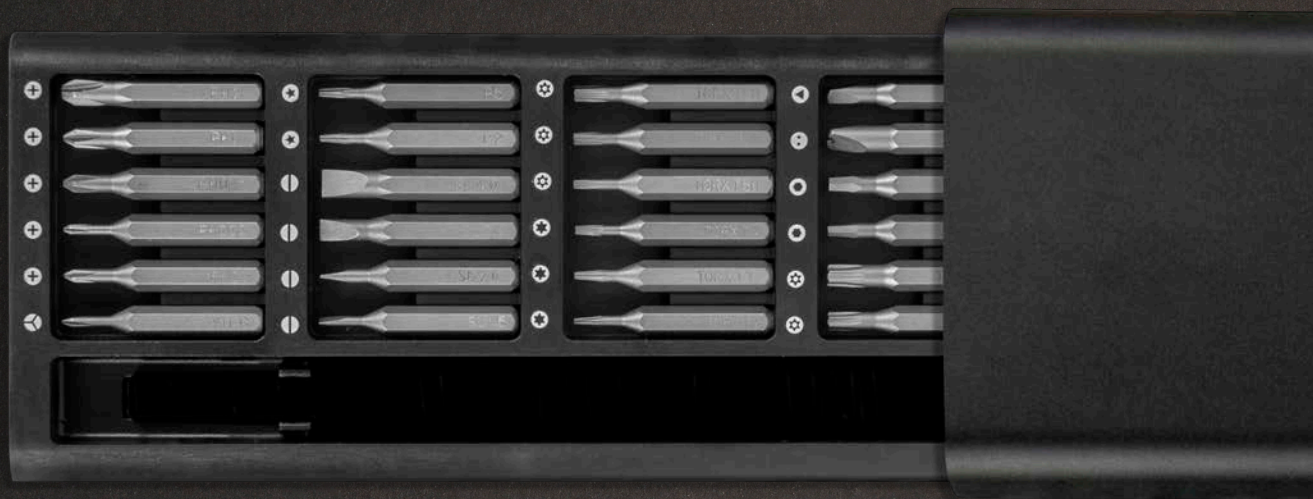

Features:

- > S2 Steel Body;
- > Aluminum box;
- > Magnetic tip.

Content: 24 pieces

- | | |
|--------------------------------|--------------------------------|
| > PH000, PH00, PH0, PH1 e PH2 | > SL1.5, SL2.0, SL3.0 e SL4.0 |
| > P2 e P5 | > T2, T3 e T4 |
| > T5H, T6H, T8H, T10 e T15H | > H1.5 e H2.0 |
| > U2.6 | > Y0.6 |
| > 2.3 | |

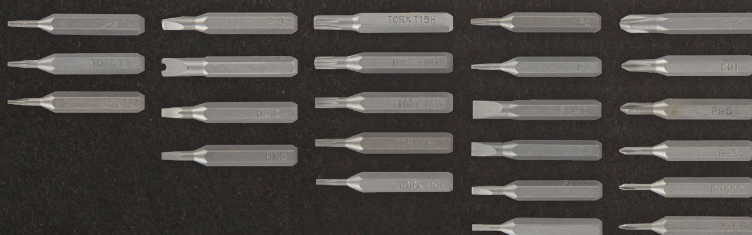

PRECISION S2 BITS WITH DRIVER

REF ^a		EAN.
VIB25	10	5604612715168

VITO

HAND TOOLS

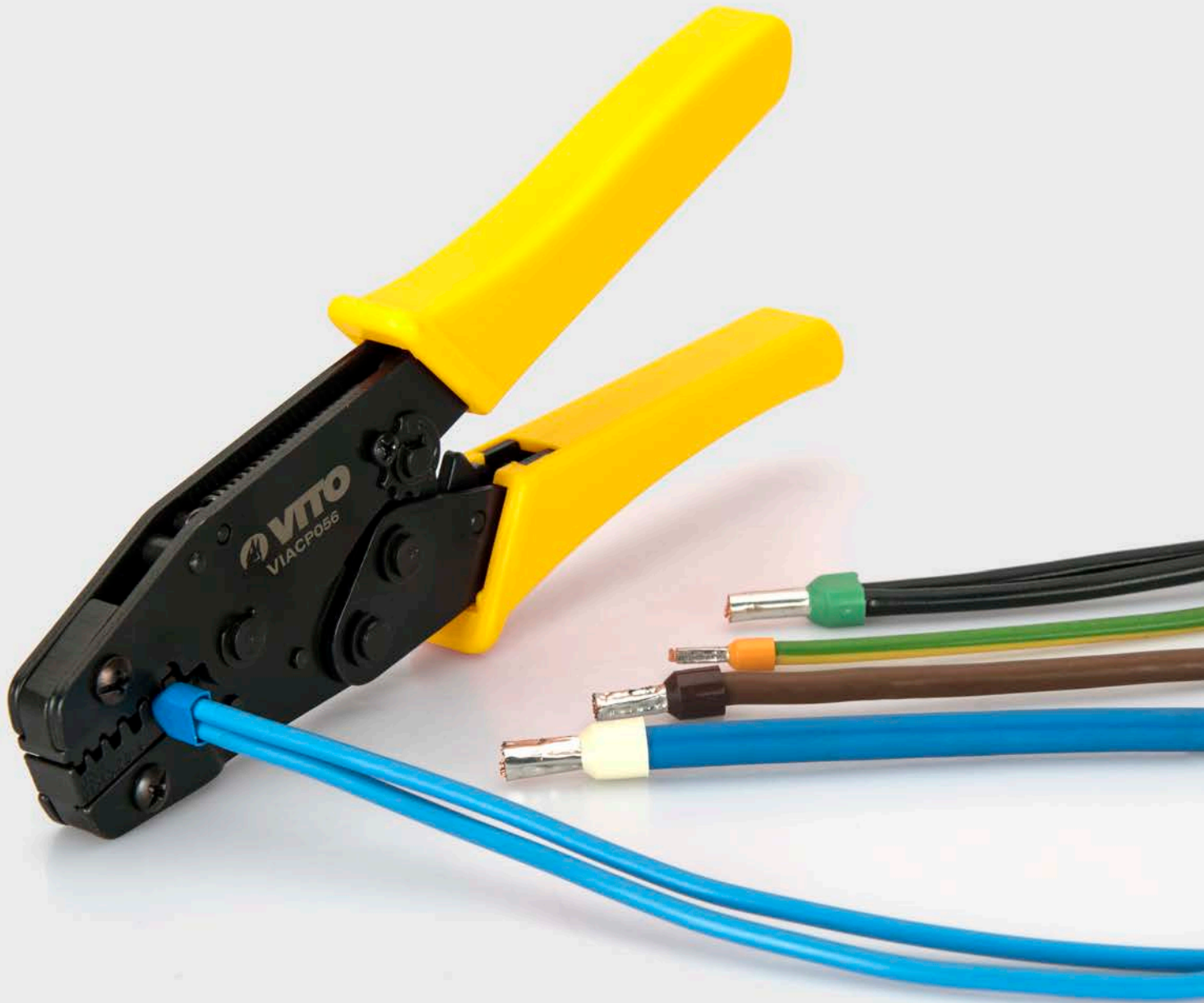

**NEW RANGE
CRIMPING AND WIRE
STRIPPING PLIERS**



The new full range of Crimping Pliers is designed to cut, strip and crimp cables safely, ensuring high quality results. They are versatile and suitable for various types of needs in telecommunications and electricity, from network cables, solid cables, modular plugs, pin-end terminals and insulated terminals. These pliers stand out for their ease of handling thanks to their soft handles and their sturdy steel body, increasing the comfort while working and ensuring a longer service life. They have the advantage of the ratchet mechanism, thus getting a precise and symmetrical crimping, as well as easy unlocking in case of mishandling.

NETWORK CABLES PLIERS

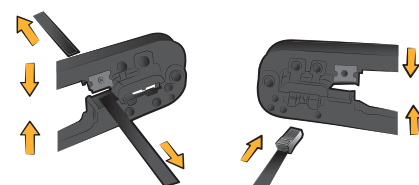

Features:

- > Professional Pliers for cutting and stripping network cables;
- > It has blades for cutting and stripping and an additional stripping device for rounded corners;
- > Equipped a ratchet mechanism, thus getting a consistent and high-quality crimping;
- > Carbon steel body;
- > Polypropylene handle.

MULTI-MODULAR PLUG CRIMPER

REF ^a	DIM.		EAN.
VIACM185	185mm	5	5604612712082

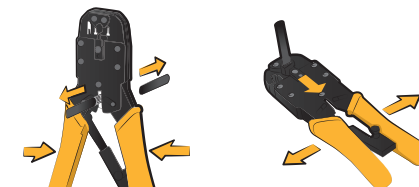

Features:

- > Professional pliers designed for cutting, stripping and crimping modular connectors
- > It has blades for cutting and stripping ensuring that the exposed wires have the correct length to fit the modular connector
- > Equipped a ratchet mechanism, thus getting a consistent and high-quality crimping;
- > Carbon steel body;
- > Polypropylene handle.

MULTI-MODULAR PLUG CRIMPER

REF ^a	DIM.		EAN.
VIACM205	205mm	5	5604612712099



PLUGS COMPRESSION CRIMPING PLIER

REF ^a	DIM.		EAN.
VIACFF	220mm	5	5604612712112

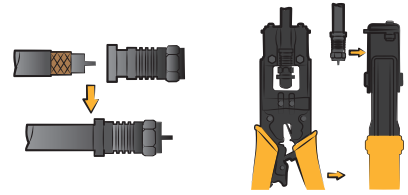
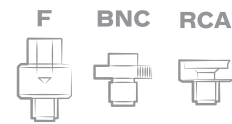

Features:

- > F - Crimping size:15,8-25,8mm;
- > BNC - Crimping size:28,2-38,2mm;
- > RCA - Crimping size:28,2-38,2mm;
- > Carbon steel body;
- > PVC handle

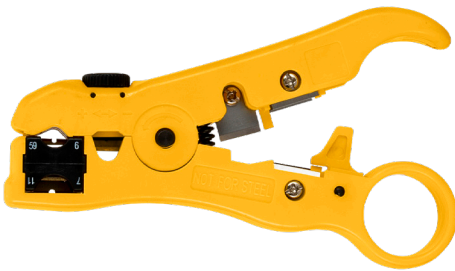

COAXIAL AND NETWORK CABLE STRIPPER

REF ^a	DIM.		EAN.
VIDCCUTP	120mm	5	5604612712105



RG6 RG7 RG11 RG59 ABS

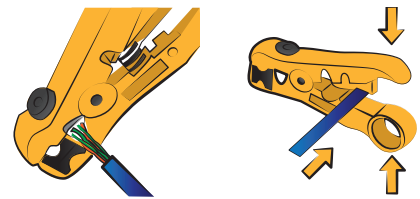

Features:

- > Universal stripper for RG6, RG7, RG11 and RG59 cables;
- > Also suitable for stripping UTP and STP cable and flat and round telephone cable
- > Adjustable through thumb screw
- > Cable cutting function;
- > Variable 4-in-1 blade, can be adjustable according to different coaxial cables;
- > ABS plastic body



PIN TERMINAL CRIMPING PLIER

REF ^a	DIM.		EAN.
VIACP056	210mm	5	5604612712143



AÇO CARBONO PP



Features:

- > Terminals type: insulated;
- > Professional Crimping Pliers with ratchet;
- > Equipped with ratchet mechanism;
- > The pressure of the ratchet can be adjusted according to the users' needs;
- > Easy unlocking in case of mishandling;
- > Carbon steel body Mn65;
- > Polypropylene handle;
- > Conductor cross - section: 0,5-6mm²;





PIN TERMINAL CRIMPING PLIER

REF ^a	DIM.		EAN.
VIACP616	210mm	5	5604612712136

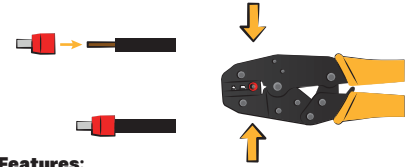

Features:

- > Professional Crimping Pliers with ratchet;
- > Equipped with ratchet mechanism;
- > The pressure of the ratchet can be adjusted according to the users' needs;
- > Easy unlocking in case of mishandling;
- > Carbon steel body Mn65;
- > Polypropylene handle;
- > Conductor cross - section: 6-16mm²;



SELF-ADJUSTING PIN TERMINAL CRIMPING PLIER

REF ^a	DIM.		EAN.
VIAACP0256	175mm	5	5604612712150

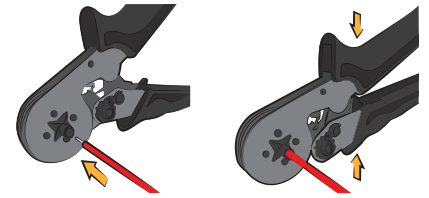

Features:

- > Self-adjustable;
- > Plug connectors: insulated and non-insulated;
- > Carbon steel body;
- > PVC coated handle.
- > Conductor cross - section: 0,25-6mm²;



INSULATED TERMINAL CRIMPING PLIER

REF ^a	DIM.		EAN.
VIACTI056	215mm	5	5604612712129

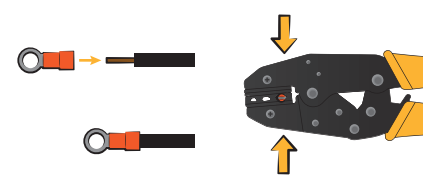

Features:

- > Plug connectors: insulated;
- > Professional Crimping Pliers with ratchet;
- > Equipped with a ratchet mechanism, requires less force, and ensures good crimping;
- > The pressure of the ratchet can be adjusted according to the users' needs;
- > Easy unlocking in case of mishandling;
- > Carbon steel body Mn65
- > Punhos em Polipropileno.
- > Conductor cross section: 0,5-6mm²;



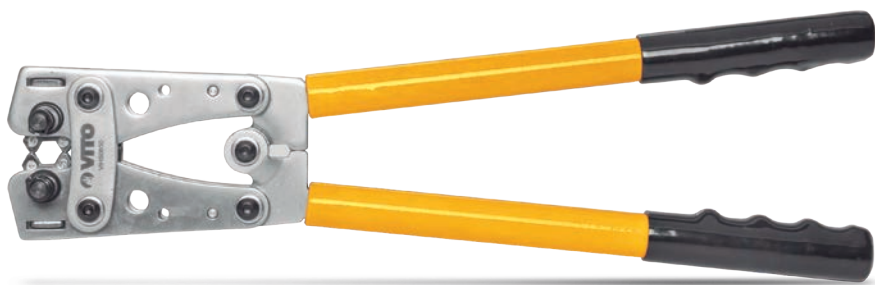

COM NOVA IMAGEM

PLUG EMBEDDING PLIER

REF ^a	DIM.		EAN.
VIHS0650	390mm	10	5604612643799

Features:

- > Terminals type: Cu/Al terminals and connecting tubes;
- > Hardened steel body;
- > Non-slip plastic handle;
- > Conductor cross section: 6-50mm²



COM NOVA IMAGEM

PLUG EMBEDDING PLIER

REF ^a	DIM.		EAN.
VIHS16120	620mm	5	5604612649227

Features:

- > Terminals type: Cu/Al terminals and connecting tubes;
- > Hardened steel body;
- > Non-slip plastic handle;
- > Conductor cross section: 10-120mm², 7-4/04AWG

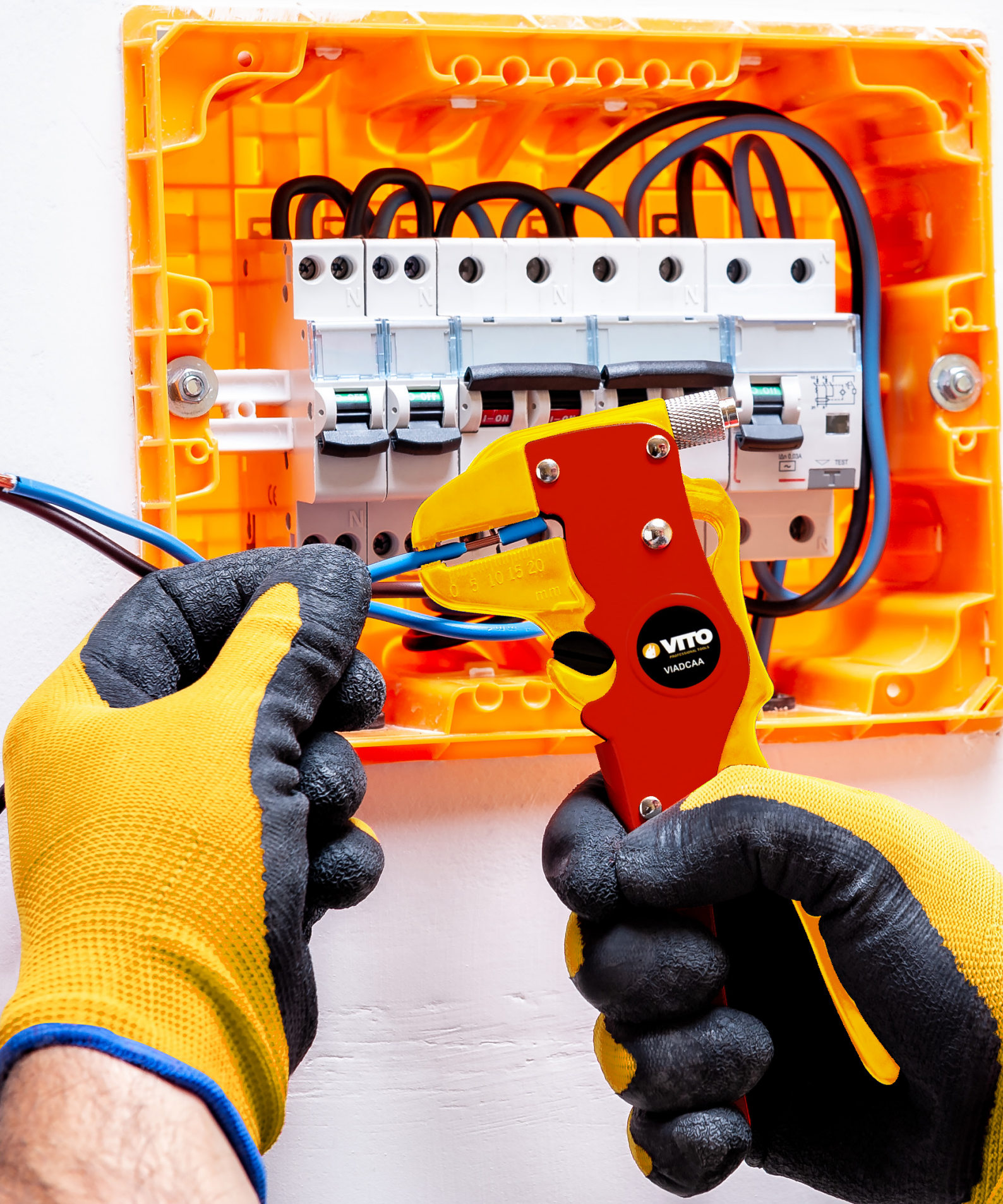

This full range of wire Stripping Pliers is suitable for cutting, stripping and crimping from the hardest to the softest wires and cables.

Easy to handle due to the ergonomic shape of the handle, these pliers provide greater comfort and control in all tasks. They also include their own blades, designed to obtain a precise cut.

This is actually a range of pliers that represents maximum safety and efficiency.



Features:

- > Type of terminals: insulated and non-insulated;
- > Cr12MoV steel jaws. For all wire with diameter between 10AWG and 22AWG (0.5 and 6.0mm²);
- > Adjust the swivel knob to strip wire up to 22AWG (0.2mm²);
- > Blades with special heat treatment. Their high quality provides an efficient cut. Suitable for copper.
- > Conductor cross - section: Insulated terminals: 10-22 AWG (0.5 ~ 6mm²). Non-insulated terminals: : 12-10 AWG (4 ~ 6.0mm²) | 22-14 AWG (0,5 -2,5mm²).

AUTOMATIC WIRE STRIPPER CUTTER AND CRIMPER

REF ^a	DIM.		EAN.
VIADCCT	205mm	5	5604612712075

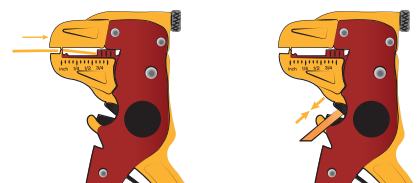

Features:

- > Strips and cuts rigid and flexible wire;
- > Strip:
Rigid wire: Conductor cross - section : 0,2~3,3mm² ;
Flexible wire: Conductor cross - section: 0,2~5,5mm² ;
- > Cut:
Conductor cross section: 0,08~2,0mm²;
Flexible wire : Conductor cross - section: 0,09~3,5mm² ;
- > Carbon steel body.

2in1

SELF-ADJUSTING WIRE STRIPPER AND CUTTER

REF ^a	DIM.		EAN.
VIADCAA	170mm	5	5604612712068



vito-tools.com



NEW

RECHARGE FOR HALF-FACE MASK RESPIRATORS



RECHARGES FOR HALF-FACE RESPIRATORS WITH DOUBLE A1P3 FILTER – 2 pieces

REF ^a		EAN. CODE
VIF757A1P3	1	5604612715175



Filter class: **A1P3**

Certification: **EN 14387:2004+A1:2008**

Filter for gases:

- **Type A1** - Application: organic vapours, solvents with boiling point > 65°C

Filter for particulates:

- **P3 protection** - Provides high efficiency (99.95%) in particulate retention.

Note: These recharges are suitable for spraying (plant protection products, for example).

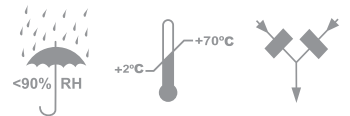

CE 0161



RECHARGES FOR HALF-FACE RESPIRATORS WITH DOUBLE ABEK1P3 FILTER – 2 pieces

REF ^a		EAN. CODE
VIF757ABEK1P3	1	5604612715182



Filter class: **ABEK1P3**

Certification: **EN 14387:2004+A1:2008**

Filter for gases:

- **Type A** - Application: Organic vapours, solvents with boiling point > 65°C;

- **Type B** - Application: Inorganic gases and vapours;

- **Type E** - Application: Sulphur dioxide and other inorganic gases and vapours

(acid products with pH < 7);

- **Type K** - Application: Ammonia and its derivatives (chemical products with pH>7).

Filter for particulates:

- **P3 protection** - Provides high efficiency (99.95%) in particulate retention.

Note: These recharges can be used in a wide range of applications due to their high protection efficiency.

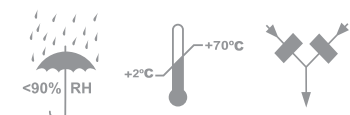

CE 0161

Recharges are for the exclusive use of the Half-face mask respirator with double filter (VIM757)



VITO

PRO POWER



SILENT AIR COMPRESSORS

THE PORTUGUESE
1988
LEADER
OF THE PACK



SILENT AIR COMPRESSORS

VITO's silent oil-free air compressors have been created to provide maximum performance and quality with less noise. They are equipped with a heat dissipation fan and overload protection to prevent the appliance from overheating, their motor power ranges from 0.7 hp to 1.5 hp to perform all your tasks in a safe and professional way.

The rubber feet protect the surfaces from scratches and stabilise the compressor by absorbing all vibrations. Easy to use and transport, they contain tanks between 6L, 24L and 50L.



Main features:

- > Low-noise, oil-free motor;
- > Quick-release fittings;
- > Corrugated filter;
- > On/off switch;
- > Thermal protection.

Technical data:

Motor power:	0,7 hp / 0,50 kW
Rotation speed:	1400 rpm
Operating pressure:	8 Bar / 115 psi
Air displacement:	89 L / min
Tank capacity:	6 L
IP code:	IP20
Sound power level (L _{WA}):	79 dB (A), k=3
Sound pressure level (L _{PA}):	57,5 dB
Product weight:	13,7 kg
Product dimensions:	460(A) x 470(B) x 145(C)mm
Weight with packaging:	15,5 kg
Packaging dimensions:	460 x 230 x 495 mm
EAN:	5604612711184

Packaging content:

- > 4x Rubber feet;
- > Air filter;
- > Set of nuts and washers.



Silent



Oil



Dissipation

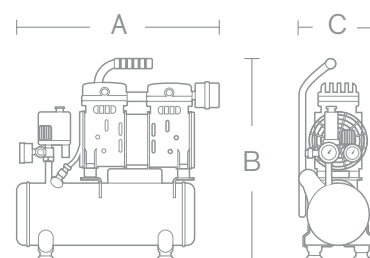

24L

VICSOS25

SILENT AIR COMPRESSOR

CS24L 8B



Main features:

- > Low-noise, oil-free motor;
- > Quick-release fittings;
- > Corrugated filter;
- > On/off switch;
- > Safety valve;
- > Thermal protection.

Technical data:

Motor power:	1 hp / 0,75 kW
Rotation speed:	1440 rpm
Operating pressure:	8 Bar / 115 psi
Air displacement:	70 L / min
Tank capacity:	24 L
IP code:	IP20
Sound power level (L _{WA}):	79 dB (A), k=3
Sound pressure level (L _{PA}):	57 dB
Product weight:	18,7 kg
Product dimensions:	515(A) x 555(B) x 310(C)mm
Weight with packaging:	21 kg
Packaging dimensions:	600 x 250 x 540 mm
EAN:	5604612711092

Packaging content:

- > 2x Fixed wheels;
- > Rubber feet;
- > Air filter;
- > Set of nuts and washers.

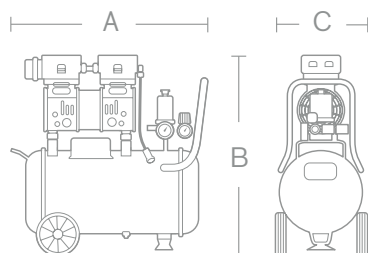

50L

VICSOS50

SILENT AIR COMPRESSOR

CS50L 8B



Main features:

- > Low-noise, oil-free motor;
- > Quick-release fittings;
- > On/off switch;
- > Double corrugated filter;
- > Safety valve;
- > Thermal protection.

Technical data:

Motor power:	1,5 hp / 1,1 kW
Rotation speed:	1440 rpm
Operating pressure:	8 Bar / 115 psi
Air displacement:	70 L / min
Tank capacity:	50 L
IP code:	IP20
Sound power level (L _{WA}):	79 dB (A), k=3
Sound pressure level (L _{PA}):	57 dB
Product weight:	30,5 kg
Product dimensions:	620(A) x 670(B) x 365(C)mm
Weight with packaging:	33 kg
Packaging dimensions:	680 x 310 x 690 mm
EAN:	5604612711108

Packaging content:

- > 2x Fixed wheels;
- > 2x Rubber feet;
- > 2x Air filter;
- > Set of nuts and washers.

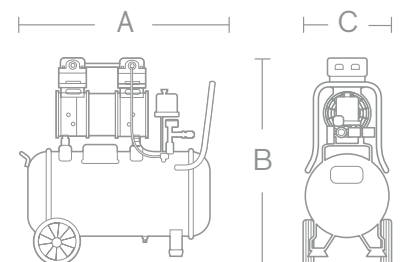

OVERVIEW

SILENT AIR COMPRESSORS



Ref. ^a	VICSOS6	VICSOS25	VICSOS50
Motor power:	0,7 hp / 0,50 kW	1 hp / 0,75 kW	1,5 hp / 1,1 kW
Rotation speed:	1400 rpm	1440 rpm	1400 rpm
Operating pressure:	8 Bar / 115 psi	8 Bar / 115 psi	8 Bar / 115 psi
Air displacement:	89 L / min	70 L / min	70 L / min
Tank capacity:	6 L	24 L	50 L
IP code:	IP20	IP20	IP20
Sound power level (L _{WA}):	79 dB (A), k=3	79 dB (A), k=3	79 dB (A), k=3
Sound pressure level (L _{PA}):	57,5 dB	57 dB	57 dB
Product weight:	13,7 kg	18,5 kg	30,5 kg
Product dimensions:	435x170x475mm	515x310x555mm	620x365x690mm
Weight with packaging:	14,8 kg	20 kg	32 kg
Packaging dimensions:	460x230x495 mm	620x260x540mm	670x320x670mm

Packaging content:

Swivel wheels:	-	-	-
Fixed wheels:	-	✓	✓
Carrying handle:	✓	✓	✓
Air filter:	✓	✓	✓
Rubber feet:	✓	✓	✓
Set of nuts and washers:	✓	✓	✓

VITO

PRO POWER

SLIDING MITRE SAW 2200W - 305mm



THE PORTUGUESE
19  88
LEADER
OF THE PACK

The VITO's sliding mitre saw (VISCME305) is the ideal tool for different cutting operations on wood, boards and similar materials. This sliding mitre saw ensures precise and reliable cuts thanks to its 2200 watts and 3900 rotations per minute (rpm) motor. It comes fully equipped with a 305mm diameter wood cutting saw blade, hex key, dust and shavings collecting bag, carbon brush set and washers set for the saw blade. To offer ensure stability and make easier to cut, this model offers a double slide rail, extension wings on both sides and rear, a turntable and a clamp.

VISCME305

Sliding mitre saw

2200W - 305mm



Technical data:

Power:	2200 W
Supply voltage:	230 V AC 50Hz
Laser power supply:	2 x 1,5 V (AAA)
No-load speed :	3900 r.p.m.
Blade diameter:	305 mm
Blade hole diameter:	30 mm
Blade thickness:	3 mm
Number of teeth:	40
Cutting angle (miter cut 0°)	
> Bevel 0°	105x330
> Bevel -45° / +45°	58/50x330
Cutting angle (miter cut 45°)	
> Bevel 0°;	105x235
> Bevel -45° / +45°	58/50x330
Sound power level (L _{WA}):	109 dB
Sound pressure level (L _{pA}):	100 db
Insulation class:	II
Weight:	24,4kg
Dimensions:	1180(A) x 490(B) x 1020(C) mm
Weight with packaging:	28,5kg
Packaging dimensions:	750x685x580mm
EAN code:	5604612709365

Packaging content:

1x	Sliding miter saw VISCME305
1x	305 mm Wood cutting saw blade
1x	Hex key
1x	Dust and shavings collection bag
1x	Clamp
1x	Rear support bar
1x	Right extension wing
1x	Left extension wing
1x	Set of carbon brushes
1x	Set of washers for saw blade

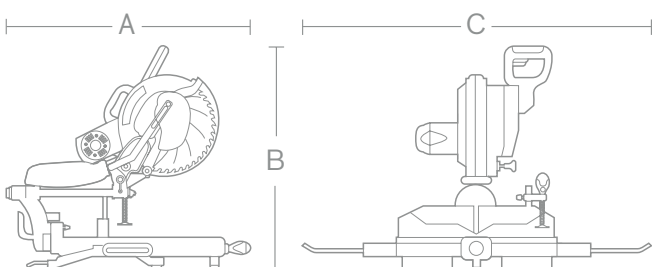



Double slide rail
Allows the cutting head to be moved along the workpieces, allowing to make larger cuts



Adjustable turntable from -45° a + 45°



Bevel cut at 45° to both sides
Indicates the selected angle on the scale placed on the slide rail support.



Side extension wings



Dust and shavings collection bag



Fixing clamp



Carrying handle



Laser guide
ensures that you cut the workpiece with the desired orientation.

Accessories for sliding mitre saw

Vito has several accessories at your disposal that you can purchase separately, either for the loss, wear or breakage of the accessory in question

> Tungsten carbide tipped blade for wood



Ref ^a :	Outer diameter	Inner diameter	≡ Saw blade diameter		EAN CODE
VIDC305	Ø305 mm	Ø30 mm	3 mm	6	5604612710873

VITO

PRO POWER

4-stroke petrol high pressure washer

250 bar 7cv



THE PORTUGUESE
19  88
LEADER
OF THE PACK

VITO PRO-POWER petrol high pressure washer is equipped with a 4-stroke engine. With 4 adaptable nozzles for different types of use and a maximum pressure of 250 bar, this high pressure washer is the best solution for all types of washing. Whether floors, boats, cars or other surfaces, it guarantees excellent cleaning results combined with low fuel consumption.

VIML70

4-stroke petrol high pressure washer



Main features:

- > Aluminium pump body, brass head;
- > 8 metres steel armed hose;
- > Carrying handle;
- > Automatic stop and adjustable jet.

Technical data:

Motor type:	4-stroke combustion
Engine power:	7 HP / 5.2 kW
Engine displacement:	207cc
Rotation speed:	3400 rpm
Fuel:	Unleaded petrol 95
Fuel tank capacity:	3,6 L
Autonomy:	2 h
Engine oil:	15W-40
Oil crankcase capacity:	1,1 L
Maximum pressure:	250 bar
Operating pressure:	180 bar
Maximum flow rate:	11,8 L/min
Flow rate:	9 L/min
High-pressure hose length:	8 m
Operating temperature:	0°~40°C
Sound power level (L _{WA}):	106 dB
Sound pressure level (L _{PA}):	92,7 dB
Product weight:	31 kg
Product dimensions:	530 (A) x 1000 (B) x 650 (C)mm
Weight with packaging:	33,5 kg
Packaging dimensions:	583 x 430 x 530 mm
EAN Code:	5604612710606

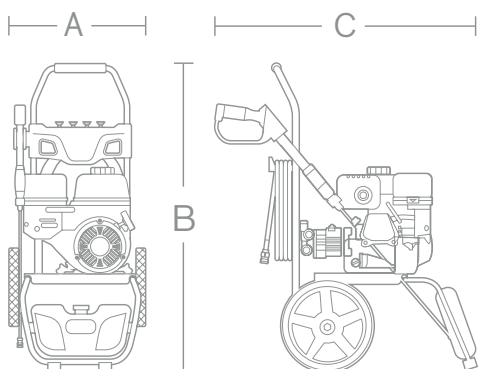

Packaging content:

- > 1x Petrol high pressure washer
- > 1x Carrying handle and set of 4 spray nozzles
- > 2x Wheel
- > 1x Spray gun
- > 1x Lance
- > 1x High-pressure hose
- > 1x Water suction hose
- > 1x Water inlet filter with foot valve
- > 1x Detergent suction filter and hose
- > 1x Hose holder
- > 1x Gun holder
- > 1x Set of screws
- > 1x Spark plug wrench
- > 1x Nozzle cleaning needle



Carrying handle
Ergonomic



Detergent tank
The petrol high pressure Washer was designed to run with almost any type of household detergents or car shampoos.



Throttle control lever
The throttle lever is used to adjust the engine's rotation speed.



Recoil starter



Fuel tank
The engine is designed to run on unleaded 95 petrol. Never use contaminated fuel or an oil and petrol mixture. Avoid dirt or water in the fuel tank. To check the fuel level and fill the tank, the engine must be stopped.

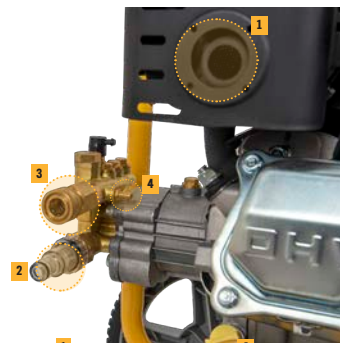

Exhaust and water inlet filter, High pressure coupling and detergent hose connector.



Transport wheels
Wheels diameter: 300 mm
Made of rigid material to withstand the most demanding floors.



Suction hose with filter:
Length: 2,86m

Spray nozzles
Included

The Petrol high pressure Washer has 4 nozzles with different colours and spray patterns. Suitable for different needs of the user.



1 Spray nozzle – red
VIML65L.M.023

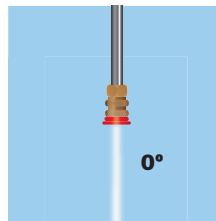

Features
> Jet angle: 0°
> Spray jet: narrow and powerful
> Washing area: Very small
> Suitable for: Surfaces in metal and/or cement surfaces (capable of withstanding high pressure washing). Not suitable for wooden surfaces.

+ Power

2 Spray nozzle – Green
VIML65L.M.024

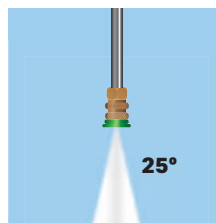

Features
> Jet angle: 25°
> Washing area: Small
> Suitable for: Surfaces capable of withstanding high pressure washing.

+ Power



3 Spray nozzle – white
VIML65L.M.025

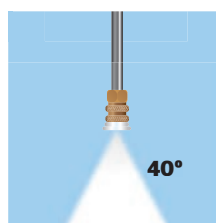

Features
> Jet angle: 40°
> Washing area: Large
> Suitable for: Any type of surface.

- Power



4 Spray nozzle – black
VIML65L.M.026

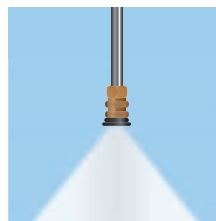

Features
> Washing area: Large
> Suitable for: Using shampoo or cleaning solutions in areas that do not require high pressure washing.

- Power







Note: Spray nozzles can also be purchased separately.





Accessories for 4-stroke petrol high pressure washer

Vito has several accessories at your disposal that you can purchase separately, either for the loss, wear or breakage of the accessory in question.

Accessories

	Ref ^a :	Designation		EAN code
	VIML65L.M.040	Suction hose with filter	1	5604612697969
	VIML70.1.C.039	Steel braided hose - 8 m	1	5604612716127
	VIML70.1.C.037	Gun	1	5604612716141
	VIML70.1.C.001	Lance	1	5604612716158



Spray nozzles for lances

	Ref ^a :	Designation		EAN code
	VIML65L.M.023	Spray nozzle - red	1	5604612690793
	VIML65L.M.024	Spray nozzle - green	1	5604612690809
	VIML65L.M.025	Spray nozzle - white	1	5604612690816
	VIML65L.M.026	Spray nozzle - black	1	5604612690823

Consumables



> Self cleaning

Suitable for a perfect vehicle wash, with high degreasing, shine and protection power.

	Ref ^a :	Designation		EAN code
	VISH1	Car shampoo - 1L	6	5604612626600
	VISH5	Car shampoo - 5L	4	5604612626617

> Huile

Suitable for high performance engines;
Optimises operation and extends engine life

	Ref ^a :	Designation		EAN code
	VIOM4T	Lubricant for 4 stroke engines - 1L	6	5604612177263

RUBBER Mallet WHITE-BLACK CONSTRUCTION



The black and white Rubber Mallet (VIMBBP450) stands out by not damaging the materials or leaving any marks during use. At each end, it is divided by two colours, one black and the other white, both have flat faces and only differ in their density. It is suitable for flooring installation and other materials that cannot be damaged and constitutes an indispensable tool for more delicate tasks.

Features:

- > Wooden handle
- > Bicolor rubber head

REF ^a	DIM.		EAN Code
VIMBBP250	315x80xØ45mm	6	5604612711115
VIMBBP450	345x95xØ60mm	6	5604612711122

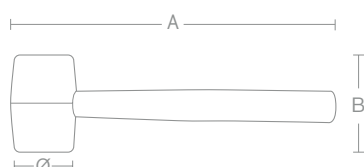

METALLIC TOOL BOX 89 PIECES

MECHANICAL TOOLS



VICMF88 content
+ ADJUSTABLE WRENCH 8"



CR-V
CHROME
VANADIUM

Content: 88 pieces.

- › 2 ratchet handles: 1/2" and 1/4";
- › 1 long nose plier: 165 mm;
- › 1 combination plier: 180 mm;
- › 1 side cutting plier: 155 mm;
- › 1 water pump plier: 255 mm;
- › 1 pressure plier: 220 mm;
- › 1 measuring tape: 19 mm x 3 m;
- › 10 carpet knife blades;
- › 1 claw hammer;
- › 1 hacksaw frame: 300 mm;
- › 1 carpet knife;
- › 2 extension bars: 75 and 125 mm;
- › 1 sliding T-bar 1/2": 250 mm;
- › 1 joint socket;
- › 1 bit screwdriver;

- › 18 socket wrenches 1/2": 10, 11, 12, 13, 14, 15, 16, 17, 18, 19, 20, 21, 22, 23, 24, 27, 30 and 32 mm;
- › 12 socket wrenches 1/4": 4, 4.5, 5, 5.5, 6, 7, 8, 9, 10, 11, 12 and 18 mm;
- › 6 bits sockets 1/4": PH1, PH2, PZ1, PZ2, 4 and 6 mm;
- › 3 slotted screwdrivers: 5 x 75 mm, 6 x 100 mm and 8 x 150 mm;
- › 2 phillips screwdrivers: PH1 x 7 mm and PH2 x 100 mm;
- › 1 adjustable wrench pro: 8";
- › 12 combination spanner: 6, 8, 9, 10, 11, 12, 13, 14, 15, 16, 17 and 19 mm;
- › 9 hexagonal key set: 1.5, 2, 2.5, 3, 4, 5, 6, 8 and 10 mm.

The Vito tool box - VICMF89 - is the ideal solution for those who need the essential tools within arm's reach. With 89 excellent quality pieces, it is one of the most complete tool boxes in the market.



REF^a



EAN.

VICMF89

1

5604612711207

NEW

**SET OF 8 BOX
SPANNERS**
MECHANICAL TOOLS



Composition

- > 6x7 mm
- > 8x9 mm
- > 10x11 mm
- > 12x13 mm
- > 14x15 mm
- > 16x17 mm
- > 18x19 mm
- > Step tommy bar

REF^a



EAN.

VIJCT8

1

5604612711221

NEW

COMBINATION SPANNER

MECHANICAL TOOLS



REF ^a	DIM.		EAN. CODE
VICBL6	6 mm	12	5604612015909
VICBL7	7 mm	12	5604612015916
VICBL8	8 mm	12	5604612015923
VICBL9	9 mm	12	5604612015930
VICBL10	10 mm	12	5604612015947
VICBL11	11 mm	12	5604612015954
VICBL12	12 mm	12	5604612015961
VICBL13	13 mm	12	5604612015978
VICBL14	14 mm	12	5604612015985
VICBL15	15 mm	12	5604612015992
VICBL16	16 mm	12	5604612016005
VICBL17	17 mm	12	5604612016012
VICBL18	18 mm	6	5604612016029
VICBL19	19 mm	6	5604612016036
VICBL20	20 mm	6	5604612016043
VICBL21	21 mm	6	5604612016050
VICBL22	22 mm	6	5604612016067
VICBL23	23 mm	6	5604612094690
VICBL24	24 mm	6	5604612016081
NEW VICBL25	25 mm	6	5604612711528
NEW VICBL26	26 mm	6	5604612711535
NEW VICBL27	27 mm	6	5604612711542
NEW VICBL28	28 mm	6	5604612711559
NEW VICBL30	30 mm	6	5604612711566
NEW VICBL32	32 mm	6	5604612711573

Features

> Chrome Vanadium body

NEW

SHORT-HANDLE ADJUSTABLE WRENCH PRO

MECHANICS TOOLS



Small-sized tool with a wide jaw opening, making easier its use in hard-to-reach areas.

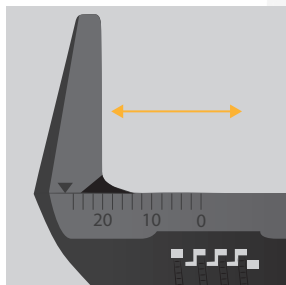

Graduated scale for easy reading.



Rigid worm-screw, smooth rotation.

CR-V
CHROME
VANADIUM

REF ^a	DIM.	OPENING		EAN.
VICICP6	6" - 150 mm	máx. 34 mm	6	5604612709754
VICICP8	8" - 200 mm	máx. 36 mm	6	5604612709747

NEW
LEATHER
GLOVE



Main features:

- Elasticated cuff;
- Comfortable and flexible.

This safety glove is a PPE which belongs to Category II, and complies with the requirements of European Regulation (EU) 2016/425.

Applicable standards: EN420:2003+A1:2009
EN388:2016

HARD WORK TOP RESISTANCE

REF ^a	DIM.		EAN.
VILPA1	10" - XL	12	5604612710583



 **VITO** PRO-POWER

OIL COMPRESSOR



24L

VIC025A

OIL COMPRESSOR



Main features:

- > On/off switch;
- > Safety valve;
- > Tank top outlet for fixed network connection;
- > Thermal protection.

Technical data

Motor power:	2,5 HP / 1,9 kW
Rotation speed:	2850 rpm
Operating pressure:	10 Bar / 145 psi
Air displacement:	206 L / min
Tank capacity:	24 L
Motor oil:	15W - 40
Oil crankcase capacity:	250 ml
IP code:	IP20
Sound power level (L_{WA}):	97 dB (a), k=3
Product weight:	24,7 kg
Product dimensions:	570(A)x 590(B) x 305(C) mm
Weight with packaging:	27 kg
Packaging dimensions:	600 x 255 x 600 mm
Barcode:	5604612710743

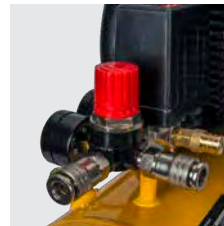

Quick-release fittings



Oil level sight glass

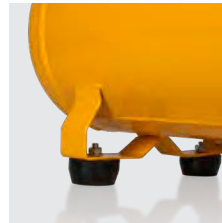

2 front rubber feet



2 wheels

Packaging content:

- > 2x Fixed wheels;
- > 2x Rubber feet;
- > Air filter;
- > Set of nuts and washers.

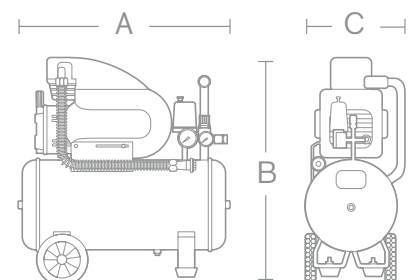

50L

VIC050A

OIL COMPRESSOR



Main features:

- > On/off switch;
- > Safety valve;
- > Tank top outlet for fixed network connection;
- > Thermal protection.

Technical data

Motor power:	2,5 cv / 1,9 kW
Rotation speed:	2850 rpm
Operating pressure:	10 Bar / 145 psi
Air displacement:	206 L/ min
Tank capacity:	50 L
Motor oil:	15W - 40
Oil crankcase capacity:	250 ml
IP code:	IP20
Sound power level (L _{WA}):	97 dB (a), k=3
Product weight:	33,2 kg
Product dimensions:	750(A)x 665(B) x 380(C) mm
Weight with packaging:	36 kg
Packaging dimensions:	780 x 325 x 700 mm
Barcode:	5604612710750

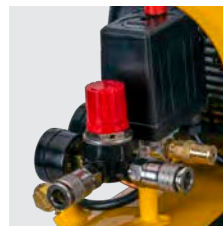

Quick-release fittings



Oil level sight glass

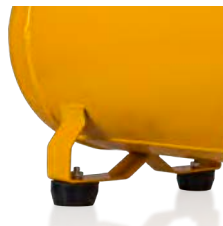

2 front rubber feet



2 wheels

Packaging content::

- > 2x Fixed wheels;
- > 2x Rubber feet;
- > Air filter;
- > Set of nuts and washers.

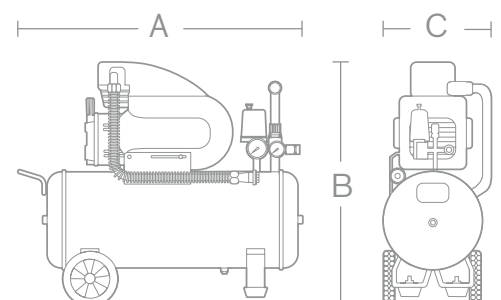

OVERVIEW COMPRESSORS



Ref. ^a	VICO25A	VICO50A
Motor power:	2,5 Hp / 1,9 kW	2,5 Hp / 1,9 kW
Rotation speed:	2850 rpm	2850 rpm
Operating pressure:	10 Bar / 145 psi	10 Bar / 145 psi
Air displacement:	206 L / min	206 L / min
Tank capacity:	24 L	50 L
IP code:	IP20	IP20
Motor oil:	15W-40	15W-40
Oil crankcase capacity:	250 ml	250 ml
Power supply:	230 V AC 50 Hz	230 V AC 50 Hz
Thermal protection:	✓	✓
ON/OFF switch:	✓	✓
Safety valve:	✓	✓
Check valve:	✓	✓
Male/female tap:	-	-
Tank top outlet for fixed network connection:	✓	✓
Outlet valve for flexible network connection:	✓	✓
Sound power level (L_{WA}):	97 dB (A), k=3	97 dB (A), k=3
Sound pressure level (L_{PA}):	95 dB (A), k=3	95 dB (A), k=3
Product weight:	24,7 kg	33,2 kg
Product dimensions:	570x590x305 mm	750x665x380 mm
Weight with packaging:	27 kg	36kg
Packaging dimensions:	600x255x600 mm	780x325x700 mm
Packaging content		
Swivel wheels:	-	-
Fixed wheels:	✓	✓
Air filter:	✓	✓
Rubber feet:	✓	✓
Set of nuts and washers:	✓	✓



VITO

PRO-POWER

NEW

130 BAR HIGH PRESSURE WASHER

Main features:

- > Aluminium carbon brush motor;
- > Aluminium pump head and body;
- > 5 metres PVC hose;
- > Telescopic carrying handle;
- > Automatic stop and adjustable jet.

Technical data:

Rated power:	1600 W
Power supply:	230V AC 50 Hz
Motor type:	Carbon brushes
Max. inlet water pressure (bar):	7 bar
Max. pressure:	130 bar
Operating pressure:	90 bar
Maximum flow rate:	6,7 L/min
Operating flow rate:	5,8 L/min
Hose length:	5 m
Operating temperature:	5° - 50°C
Sound pressure level (L _{PA}):	74 dB, K=3
Sound power level (L _{WA}):	89 dB, K=3
IP code:	IPX5
Product weight:	10,3 kg
Product dimensions:	370 (A) x 870 (B) x 410 (C) mm
Weight with packaging:	12,4 kg
Packaging dimensions:	400x365x720 mm



1.2 L capacity detergent tank



Detergent dosing button



Hose holder

Packaging content:

- 1x Trigger gun
- 1x Lance with spray nozzle
- 1x PVC high pressure hose
- 1x Gun set holder (gun+lance)
- 1x High pressure hose holder
- 2x Accessory holder
- 1x Water inlet filter
- 1x Set of screws
- 1x Cleaning needle for nozzle

REF^a

VIML130WR2LITE



1

EAN

5604612710422

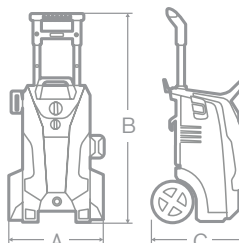



NEW
PU EAR PLUG

The PU ear plugs from Vito Security are suitable for a noisy work environment and should be used only for a short period of time. This ergonomically-shaped, mouldable product is easy to fit into the ear canal and helps to reduce exposure to hazardous noise and other loud sounds.



34
dB



FITTING INSTRUCTIONS

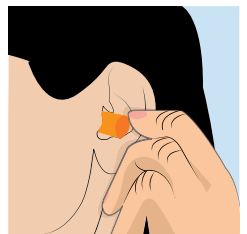
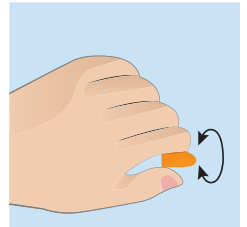

REF^a



EAN.

VIP1374A

100

5604612711085

CE 0194

Model n. **SE1374**
Lot no. **12/2020**

Conforme com
o Regulamento
(UE) 2016/425

EN352-2:2002

OXIS



OXIS

VITO SECURITY presents the OXIS range of footwear intended for users who value safety and comfort in the workplace.

These shoes or boots made with high quality materials stand out for its protection, absorption and resistance.

The toe cap is made of composite for greater comfort and protection against scratches; the double density polyurethane sole prevents wear and slipping.

Suitable for industrial, transport and warehouse work, OXIS protective footwear is the best choice for everyday use.





SUEDE SHOE

Safety classification	SIP
Exterior coating	Pele camurça
Midsole	Aramid synthetic fiber
Sole	Double density PU
Toe cap	Composite

EN ISO 20345:2011

This model complies with the requirements of Regulation 2016/425 on personal protective equipment.

REF ^a	Nº		EAN.
VISO37	37	10	5604612710019
VISO38	38	10	5604612710026
VISO39	39	10	5604612710033
VISO40	40	10	5604612710040
VISO41	41	10	5604612710057
VISO42	42	10	5604612710064
VISO43	43	10	5604612710071
VISO44	44	10	5604612710088
VISO45	45	10	5604612710095
VISO46	46	10	5604612710101



MAIN FEATURES

- > Anti-static sole;
- > Energy absorption of heel region;
- > Anti-perforation sole (aramid synthetic fibre);
- > Anti-slip SRC;
- > Composite toe caps.



SUEDE BOOT

Safety classification	SIP
Exterior coating	Pele camurça
Midsole	Aramid synthetic fiber
Sole	Double density PU
Toe cap	Composite

EN ISO 20345:2011

This model complies with the requirements of Regulation 2016/425 on personal protective equipment.

REF ^a	Nº		EAN.
VIBO37	37	10	5604612710118
VIBO38	38	10	5604612710125
VIBO39	39	10	5604612710132
VIBO40	40	10	5604612710149
VIBO41	41	10	5604612710156
VIBO42	42	10	5604612710163
VIBO43	43	10	5604612710170
VIBO44	44	10	5604612710187
VIBO45	45	10	5604612710194
VIBO46	46	10	5604612710200



MAIN FEATURES

- > Anti-static sole;
- > Energy absorption of heel region;
- > Anti-perforation sole (aramid synthetic fibre);
- > Anti-slip SRC;
- > Composite toe caps.



 **VITO** SECURITY

NEW

**KNIFE SHARPENER
WITH SUCTION CUP**

CUTTING



Very convenient and easy to use, this tool helps you to keep cutting edges always sharp at any place. For accurate sharpening, simply pass the knife cutting edge gently through the notch until it is properly sharpened. The VITO knife sharpener makes the sharpening process easier, faster and safer, ensuring the quality and durability of your blades.



Suction cup:
The suction cup makes it easier to secure the knife sharpener over a flat surface.

EASY TO USE

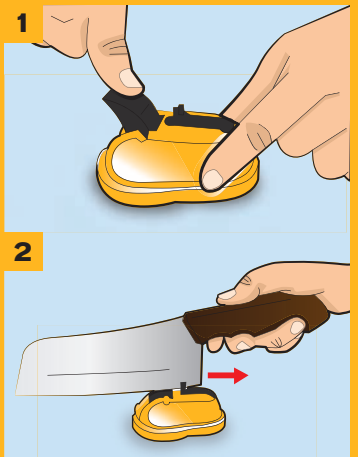

REF^a

AxBxC



EAN.

VIAFB

93x41x67mm

63 g

1

5604612709716

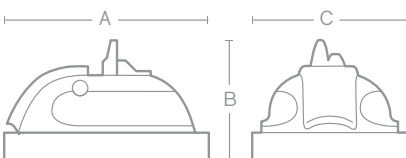



VITO

PRO-POWER

100A FLUX-CORED WELDING MACHINE

VITO PRO-POWER

VIMS F100 (MIG-100) - 2020		EN/IEC 60974-1	
S.N.			
50A/16.5V - 100A/19V			
α (%)	10	60	100
I_d (A)	100	40	30
U_d (V)	19	16	15.5
U_i	230V	I_{max}	13A
		I_{min}	5A
IP21S	H		

RUA DA GÂNDARA, 664 | 4520-606 SÃO JOÃO DE VEI | S. M. FEIRA - PORTUGAL



MIG
Metal Inert Gas Welding
100 A



VITO PRO-POWER

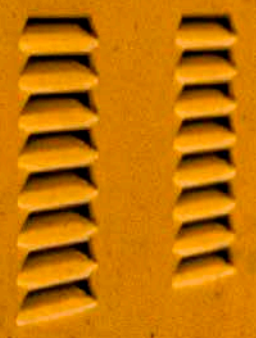



100A FLUX-CORED WELDING MACHINE

The new VITO Pro-Power flux-cored welding machine is very practical and sturdy and stands out for its quality, reliability and robustness for welding tasks. This appliance is ideal for metallurgical or metalworking tasks and is characterised by its accuracy and excellent welding quality on stainless steel and on nickel copper and aluminium alloys. With the versatile and rigorous flux-cored welding machine, you get the best results in a simple, quick and effective way.



Main features:

- > Cooling system;
- > Thermal overload protection;
- > Welds without a shielding gas;
- > Wire feed speed controller.



Technical data:

Rated power:	3,6 kVA
Welding current:	50 - 100 A
Duty cycle (230V):	10% - 100A
Fuse:	16 A
Power factor (cos Ø):	0,7
Adjustment positions:	4
Wire spool (maximum):	1 Kg
Welding wire diameter:	0,6 - 0,9 mm
Ground clamp cable:	1,5 m
Welding gun cable:	1,9 m
Power cord:	1,8 m
Insulation class:	H
Nível de potência sonora:	73 dB
IP code:	IP21S
Product weight:	12,4 Kg
Product dimensions:	185 x 345 x 430 mm
Weight with packaging :	13,9 Kg
Packaging dimensions:	465 x 225 x 395 mm



Wire feed speed controller



Carrying hander



Flux-cored wire spool



Included accessories

Packaging content:

- | | |
|-----------------|-------------------------------|
| 1x Welding mask | 1x Handle for welding mask |
| 1x Wire spool | 1x Wire brush/chipping hammer |

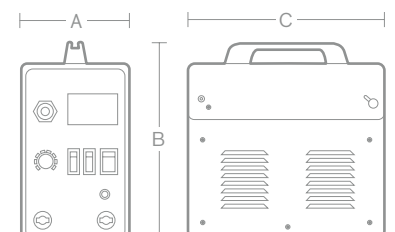

REF^a
VIMSF100



EAN
5604612705855

WELDING ACCESSORIES

These accessories are ideal to be used with the new flux-cored welding machine (VIMSF100).



0,6 MM

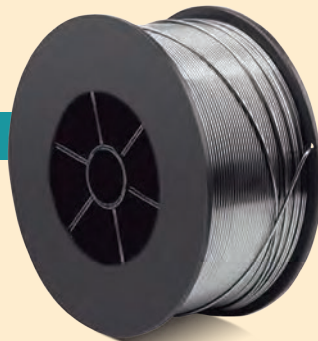

FLUX-CORED WIRE SPOOL

REF ^a	Ø	Weight		EAN
VIMSF.06045	0,6	0,45 kg	1	5604612709617
VIMSF.061	mm	1 kg	1	5604612709624



0,9 MM

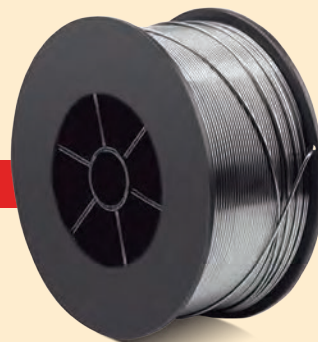

FLUX-CORED WIRE SPOOL

REF ^a	Ø	Weight		EAN
VIMSF.09045	0,9	0,45 kg	1	5604612709648
VIMSF.091	mm	1 kg	1	5604612709631



vito-tools.com



ARGUS



ARGUS

Who says it's impossible to work in a stylish way?

The ARGUS SHOES combine design with the quality of a highly safe and productive work. It features an anti-static sole with energy absorption of heel region and it is anti-slip SRA-rated.

The shoes are made with high quality materials, it has a composite toecap for added comfort and protection against scratches.

Comfortable and resistant, it provides the best comfort conditions for your feet in day-to-day life.

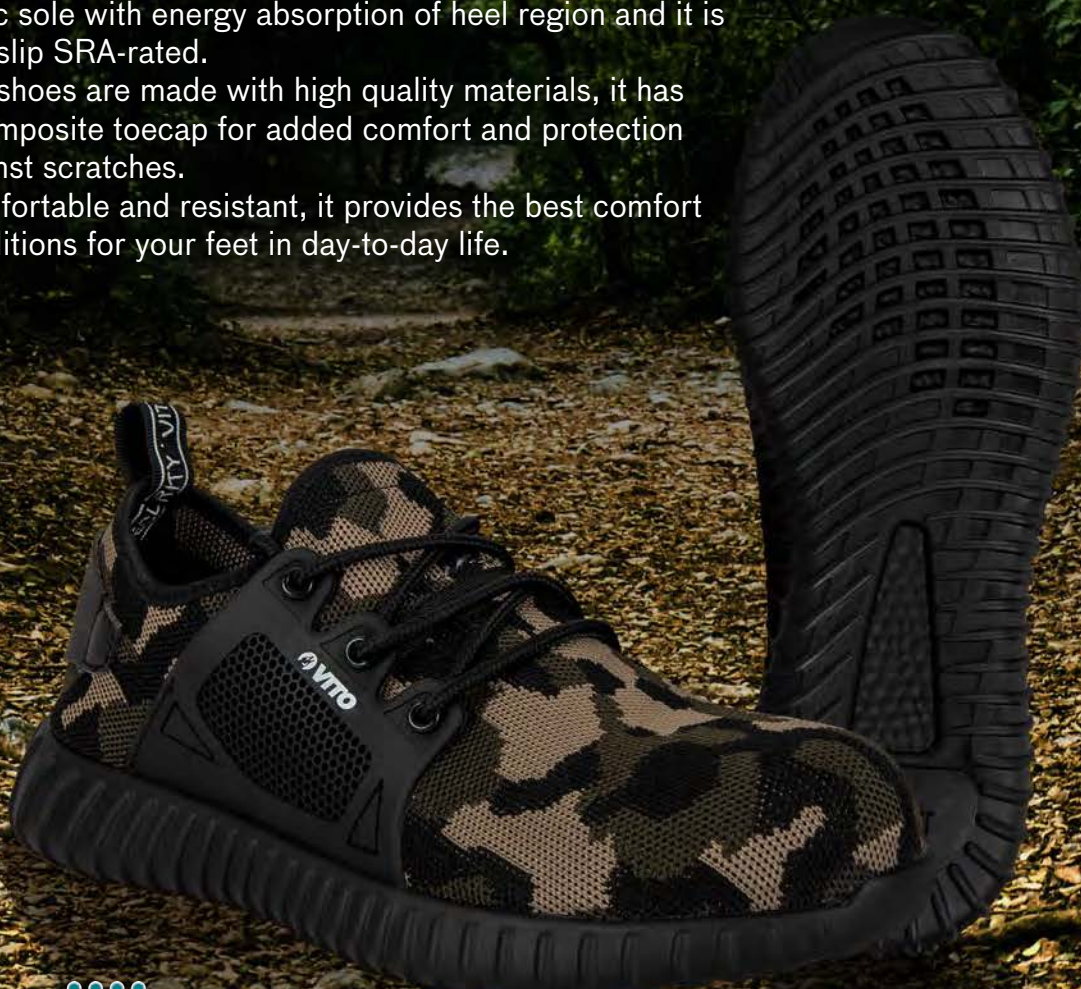



SHOE ARGUS NON-METAL

Safety standard	S1P
Upper	Fabric
Midsole	Aramid synthetic fiber
Sole	Anti-perforation
Toe cap	Composite



EN ISO 20345:2011

This model complies with the requirements of Regulation 2016/425 on personal protective equipment.

REF ^a	N°		EAN.
VISAR37	37		5604612704933
VISAR38	38		5604612704940
VISAR39	39		5604612704957
VISAR40	40		5604612704964
VISAR41	41		5604612704971
VISAR42	42	10	5604612704988
VISAR43	43		5604612704995
VISAR44	44		5604612705008
VISAR45	45		5604612705015
VISAR46	46		5604612705022

MAIN FEATURES:

- > Anti-static sole;
- > Energy absorption of heel region;
- > Anti-perforation sole (aramid synthetic fibre);
- > Anti-slip SRA;
- > Composite toe caps.



MULT



 **VITO** SECURITY

MUT

MUT shoes combine all safety conditions for more comfort and protection at work. These shoes were made with high-quality materials and have a protective toecap, energy absorption of the heel region and an anti-perforation sole to prevent slipping on ceramic tile floors and ensure greater safety and protection for the feet. The light and bold MUT shoes stand out for its versatility and penetration-resistant midsole, provide the best conditions for day-to-day comfort.





SAFETY SHOE MUT

Safety standard	SIP – Class 1
Upper	Fabric
Midsole	Aramid synthetic fiber
Sole	EVA + rubber
Toe cap	Composite

EN ISO 20345:2011

This model complies with the requirements of Regulation 2016/425 on personal protective equipment.

MAIN FEATURES:

- > Anti-static sole;
- > Energy absorption of heel region;
- > Anti-perforation sole (aramid synthetic fibre);
- > Anti-slip SRA;
- > Composite toe caps



REF ^a	Nº		EAN.
VISMU36	36		5604612709549
VISMU37	37		5604612709556
VISMU38	38		5604612709563
VISMU39	39	10	5604612709570
VISMU40	40		5604612709587
VISMU41	41		5604612709594
VISMU42	42		5604612709600



 **VITO** SECURITY