

## STEP Series RECESSED WALL LIGHT

Outdoor Lighting



ASLO's 2.8W Recessed Rectangular Wall Light is a lighting solution, suitable for enhancing architectural elements in indoor and outdoor environments. With a 3CCT selector (3000K/4000K/6000K), it adapts the light to the environment, while the 120° beam angle ensures wide and uniform lighting. The polycarbonate structure and IP65 rating ensure resistance to dust, humidity, and water. It also features a polycarbonate (PC) diffuser for greater visual comfort.

### Main features:

- > Adjustable lighting with 3 colour temperature selector;
- > Polycarbonate diffuser, providing an even light;
- > 120° beam angle for wide illumination;
- > Discrete integration, thanks to recessed installation;
- > Polycarbonate structure that ensures greater robustness and resistance to corrosion;
- > IP65 rating, ideal for indoor and outdoor spaces;
- > Insulation class II for enhanced safety;

## Recessed wall Light

STEP Series



### Technical data:

- > 3CCT: 3000K, 4000K e 6000K
- > Input voltage: 220-240V AC
- > Frequency: 50-60Hz
- > Service life: 25.000h
- > Switch cycles: 10.000
- > Diffuser: polycarbonate
- > Insulation class: II



Beam angle:  
120°



LED SMD 2835



Compatible with  
standard back  
boxes

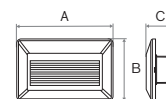

REF.	Colour	Power	Useful lumens	CRI	A	B	C			EAN
ASSTEP28C3PR	●	2,8W	230Lm <sup>360°</sup>	>80	135mm	86mm	37,5mm	1	100	5604612765866
ASSTEP28C3BR	○	2,8W	230Lm <sup>360°</sup>	>80	135mm	86mm	37,5mm	1	100	5604612765859

# Aslo

BRIGHTER LIFE

## SOLAR FLOODLIGHT

MINI FOLD Series

Solar lighting - Floodlights

aslo.pt



# Aslo

ASLO's Solar Floodlight is a smart outdoor lighting solution, combining solar energy with a PIR motion sensor to enhance security and visibility. This model with ABS structure incorporates a 3 CCT colour temperature selector, making it possible to adapt the light tone to the environment in which it is used. In addition, the device can be switched on and off using a button that allows you to adjust the brightness and choose between three operating modes (25%, 50% and 100%), making it ideal for commercial, industrial, or domestic environments. With a surface-mounted wall installation, the floodlight can be used in entrances, façades, garages, or outdoor areas. The IP54 and IK05 ratings and insulation class III reinforce the equipment's resistance and safety, while EMC and RoHS certifications ensure compliance with European standards.



## Technical data:

### Solar LED floodlight:

Use:	Outdoors
Installation mode:	Surface-mounted
LED type:	LED SMD 2835
Power/ Lumens:	10W/ 1200Lm
Efficiency:	120 Lm/W
Beam angle:	120°
Dimmable:	No
Operating temperature:	-20°~ 65°C
IP rating:	IP54
IK rating:	IK05
Material:	ABS
Standards:	EMC / RoHS

### Battery:

Battery (lithium-ion):	1x3,7V 2,2Ah 18650
Solar charging:	6-8h
Autonomy:	8-10h
Replaceable battery:	Yes

### Solar panel:

Power:	1,5W
Voltage:	5,5V
Material:	Monocrystalline

## Main features:

- > PIR motion sensor;
- > Three adjustable brightness modes: 25%, 50%, and 100%;
- > Adjustable colour temperature 3CCT;
- > ON/OFF switch;
- > Wide beam angle of 120°;
- > Robust ABS structure;
- > IP54 rating;
- > IK05 impact resistance;
- > Surface mounting on a wall;
- > Insulation class III for enhanced safety;
- > EMC and RoHS certifications that guarantee European compliance.

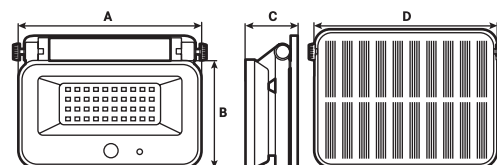

## SOLAR FLOODLIGHT

REF.	W	LM	K	AxBxCxD			EAN.
ASMFOLD3	10	1200	3000-4000-6500	140x85x42x98 mm	1	24	5604612762933



- 1 - Solar Panel
- 2 - Panel
- 3 - Infrared Sensor
- 4 - Battery Level Alert
- 5 - Bracket
- 6 - ON/OFF switch
- 7 - Colour Temperature Selector
- 8 - Battery Compartment

Adjustable colour temperature 3CCT

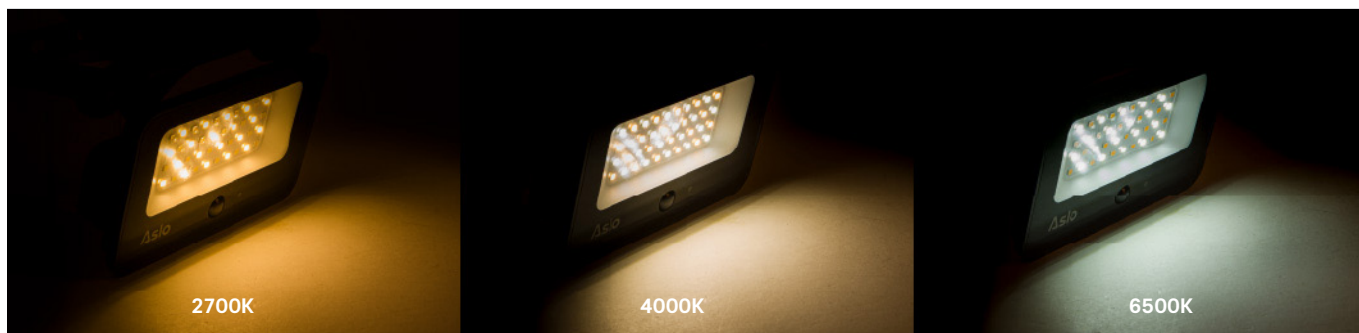

3 adjustable brightness modes



Wall mounting

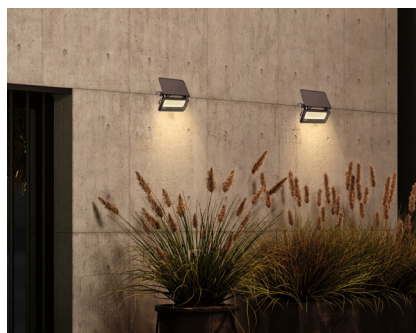

Pole mounting



Beam angle

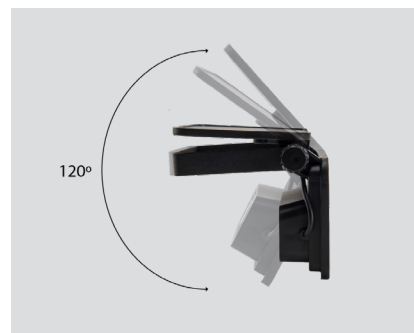

# Aslo

**BRIGHTER LIFE**

# Aslo

BRIGHTER LIFE

**USB RECHARGEABLE  
CABINET LIGHT**

Indoor Lighting



- Ultra-thin design and aluminium structure, combining elegance with strength
- PIR motion sensor, ideal for automatic activation in storage areas
- Wide, uniform lighting ensured by the PC diffuser and 120° beam angle
- Three operating modes for greater control and versatility



## Main areas of application:



ASLO's USB Rechargeable Cabinet Light offers versatile lighting for indoor environments and can be integrated into cabinets, shelves, and storage areas. Equipped with a dimmable luminous flux and a colour temperature selector (3CCT), it allows you to adjust both the tone and intensity of the light according to use. As such, it stands out for its versatility which, thanks to the integrated control buttons, allows the lighting to be adapted to the environment or task in a simple and intuitive way.

With a magnetic base, it ensures practical installation, allowing the luminaire to be attached and removed without tools. Plus, the super-slim design with an aluminium structure blends in nicely with any interior. The PC diffuser ensures uniform light distribution, preventing glare and creating

a more comfortable environment in storage areas. The presence of a PIR motion sensor, with a detection angle between 90° and 120°, adds a layer of convenience, activating the light only when necessary. With three operating modes (on, off and sensor), this light easily adapts to a variety of uses, being especially useful on walls, cabinets, or shelves. The rechargeable USB power supply eliminates the need for fixed cables, which translates into freedom of movement when positioning and using the light, representing a functional solution for everyday use. Furthermore, the IP20 rating, insulation class III, and EMC and RoHS certifications reinforce the luminaire's safety and compliance, ensuring proper operation indoors.

## USB rechargeable cabinet light

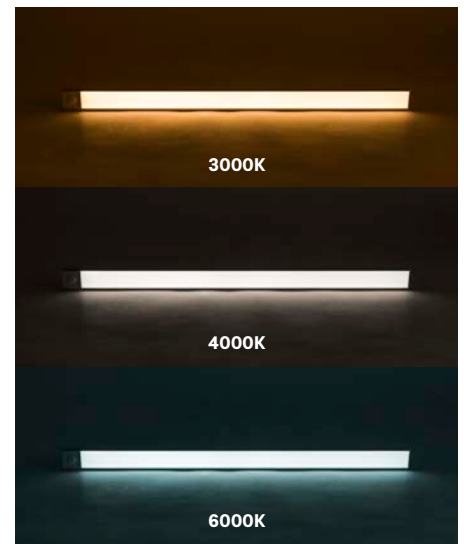
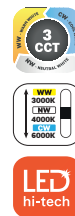

### Cabinet light:

- > LED SMD 4014
- > 3CCT: 3000K, 4000K and 6000K
- > Dimmable: Yes
- > Operating mode: On / Off / Auto
- > Installation: Surface-mounting – Magnetic base
- > Operating modes: 1 = Switch on / 2 = Switch off / 3 = Sensor
- > IP rating: IP20
- > Structure: aluminium
- > Diffuser: polycarbonate (PC)
- > Insulation class: III

### Sensor:

- > Detection angle: range 90°~120°
- > Detection area: height 1~3m
- > Motion sensor – PIR
- > Timing: 15 s

### Battery:

- > Lithium-ion battery: 3,7V, 1500mAh 9.62Wh
- > Autonomy (fully charged): 8h
- > Charging time: 5h



Colour temperature selector and luminous flux adjustment



Operating mode selector (On / Off / Auto)



USB-C charge



Luminous flux: press and hold the button to increase/decrease the light

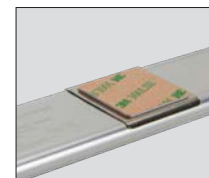

Magnetic installation



Accessories included

REF.	Colour	Power	Lumens	CRI	A	B	C	⊠	⊞	EAN
ASCAB400C3	●	2W	90~100Lm	80	400mm	9mm	40mm	1	25	5604612740238
NEW ASCAB600C3	●	3W	90~100Lm	80	600mm	9mm	40mm	1	25	5604612769345

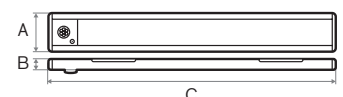

## Fibreglass distribution box SMC – Opaque door

- IP rating: IP65 ○ IK rating: IK09
- Insulation class: II ○ Material: Fibreglass reinforced polyester (SMC)



Waterproof box seal



Markings for fixing supports



Box interior



Accessories included

The new SMC distribution box is a type of distribution box made of fibreglass-reinforced polyester. Particularly suitable for corrosive and humid environments. It has the same strength as a metal cabinet, but weighs only 1/3 as much. Supplied without a mounting plate, it is designed to be installed with various electrical components, according to different control function requirements, using the plates (metal or resin) and/or chassis for modular equipment, available for purchase separately.

### Applications:

All types of residential, commercial, and industrial electrical installations that require high protection against dust and water:

- > Power Distribution Box
- > Junction Box
- > Electric Meter Box
- > Box for Electrical Control System
- > Modular box/panel for circuit breakers

## Fibreglass distribution box SMC – Opaque door

IP65



### Main features:

- > Insulation voltage -  $U_i$  (V) - 600V
- > Maximum opening: 180° door
- > Operating temperature: -60°C~150°C
- > Mounting type: Surface-mounted or semi-recessed
- > Suitable environment: Interior/exterior and industrial
- > Service life: 20 years

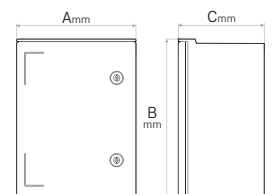

REF.	Colour	Dimensions (AxBxC)	📦	EAN
ASCSMC403020	● RAL 7035	300x400x200mm	1	5604612761615
ASCSMC504020	● RAL 7035	400x500x200mm	1	5604612761622
ASCSMC604023	● RAL 7035	400x600x230mm	1	5604612761639
ASCSMC605023	● RAL 7035	500x600x230mm	1	5604612761646
ASCSMC806030	● RAL 7035	600x800x300mm	1	5604612761653

### Metal chassis for distribution box SMC

Structure: Galvanised iron



Accessories included

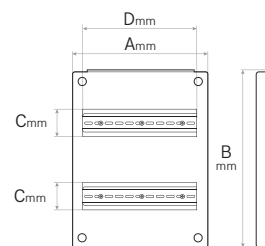

REF.	Colour	Modules	Dimensions (AxBxCxD)			EAN
ASCMSMC4030	●	2 rows x 12	255x355x46x220mm	1	10	5604612761769
ASCMSMC5040	●	3 rows x 18	355x455x46x330mm	1	8	5604612761776
ASCMSMC6040	●	4 rows x 18	355x555x46x330mm	1	5	5604612761783
ASCMSMC6050	●	4 rows x 23	455x555x46x420mm	1	6	5604612761790
ASCMSMC8060	●	5 rows x 26	555x755x46x475mm	1	4	5604612761806

### Metal plate for distribution box SMC

Galvanised iron

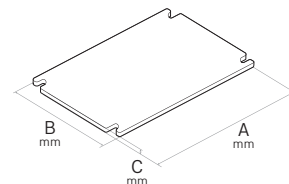

REF.	Dimensions (AxBxC)			EAN
ASPMSMC4030	355x255x1,5mm	1	10	5604612761660
ASPMSMC5040	455x355x1,5mm	1	10	5604612761677
ASPMSMC6040	555x355x1,5mm	1	10	5604612761684
ASPMSMC6050	555x455x1,5mm	1	10	5604612761691
ASPMSMC8060	755x555x1,5mm	1	5	5604612761707

### Epoxy resin plate for distribution box SMC

Epoxy resin

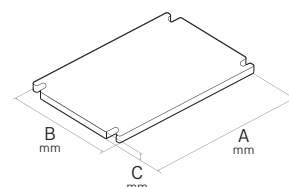

REF.	Dimensions (AxBxC)			EAN
ASPRESMC4030	355x255x3mm	1	20	5604612761714
ASPRESMC5040	455x355x3mm	1	30	5604612761721
ASPRESMC6040	555x355x3mm	1	15	5604612761738
ASPRESMC6050	555x455x3mm	1	15	5604612761745
ASPRESMC8060	755x555x3mm	1	15	5604612761752

### Lock with key for fibreglass distribution box SMC



Includes 2 keys

REF.			EAN
ASFCSMC	1	1	5604612761820

# Aslo

**BRIGHTER LIFE**



## **POLYCARBONATE TRIMS**

Indoor Lighting - Recessed

[aslo.pt](http://aslo.pt)

# PC TRIMS

ASLO's new range of Polycarbonate Trims has been developed to offer a modern, resistant, and aesthetically elegant solution for lighting systems in drop ceilings. Manufactured with high-quality materials, these trims combine lightness, durability, and versatility, adapting perfectly to different environments. Made of high-strength polycarbonate (PC), they are the ideal recessed lighting solution, offering durability, maintaining their colour and integrity over time, and discreet integration into any ceiling.

Notable for their UV protection, preventing yellowing and long-term degradation of polycarbonate, and for their flame retardancy, they ensure greater safety, longevity, and anti-ageing properties.

Ideal for residential, commercial, and corporate applications, this new line has been designed to meet the efficiency, aesthetic, and durability requirements of modern lighting projects.

## **Areas of application:**

- Houses (living rooms, bedrooms, hallways, kitchens, bathrooms (IP65), etc...
- Offices
- Commercial spaces
- Exhibition areas, museums, etc.
- Restaurants, cafés, supermarkets, etc.

## **Trims with levelled vs retracted light bulbs:**

When deciding between trims with levelled light bulbs and rings with retracted light bulbs, it is essential to analyse the differences in lighting effect and design. Trims with levelled light bulbs offer more direct and intense lighting, while trims with retracted light bulbs provide a more focused beam of light that is more comfortable for the eyes.

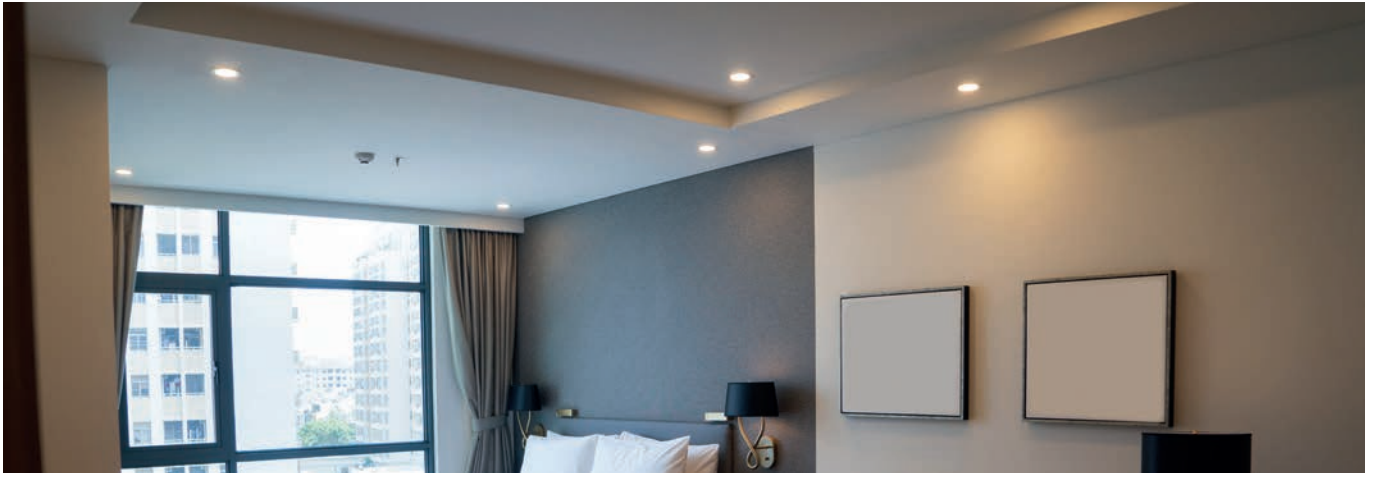

## ADJUSTABLE PC ROUND TRIM

### Technical data:

- > GU10 light bulb not included
- > GU10 lamp holder not included
- > IP rating: IP20
- > Housing: polycarbonate
- > Insulation class: II
- > Flame retardant

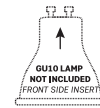
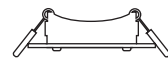

REF.	Colour	Dimensions				EAN
ASARPC670PR	●	90x29mm	70~75mm	1	100	5604612759964
ASARPC670BR	○					5604612759957

## ADJUSTABLE PC SQUARE TRIM

### Technical data:

- > GU10 light bulb not included
- > GU10 lamp holder not included
- > IP rating: IP20
- > Housing: polycarbonate
- > Insulation class: II
- > Flame retardant

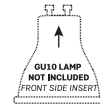

REF.	Colour	Dimensions				EAN
ASAQPC1280PR	●	93x93x27mm	75~85mm	1	100	5604612759988
ASAQPC1280BR	○					5604612759971

## ADJUSTABLE PC ROUND TRIM

### Technical data:

- > GU10 light bulb not included
- > GU10 lamp holder not included
- > IP rating: IP20
- > Housing: polycarbonate
- > Insulation class: II
- > Flame retardant

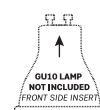

REF.	Colour	Dimensions				EAN
ASARPC1775PR	●	90x30mm	75~80mm	1	100	5604612760007
ASARPC1775BR	○					5604612759995



Some presentation suggestions

## ADJUSTABLE PC ROUND TRIM

### Technical data:

- > GU10 light bulb not included
- > GU10 lamp holder not included
- > IP rating: IP20
- > Housing: polycarbonate
- > Insulation class: II
- > Flame retardant
- > Reflectors available in 3 colours

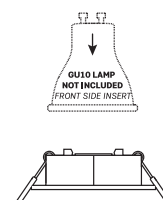

REF.	Colour	Dimensions				EAN
ASARPC375PR	●	90x29mm	75~80mm	1	100	5604612759919
ASARPC375BR	○					5604612759902

## ADJUSTABLE PC SQUARE TRIM

### Technical data:

- > GU10 light bulb not included
- > GU10 lamp holder not included
- > IP rating: IP20
- > Housing: polycarbonate
- > Insulation class: II
- > Flame retardant
- > Reflectors available in 3 colours

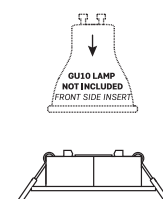

REF.	Colour	Dimensions				EAN
ASAQC380PR	●	93x93x29mm	75~80mm	1	100	5604612759933
ASAQC380BR	○					5604612759926

## ACCESSORIES FOR TRIMS (NOT INCLUDED)

ASRPC5535OR  
**Golden Rose**  
Polycarbonate  
Reflector

> 55x34mm

EAN		
5604612760793	1	100

ASRPC5535CR  
**Chrome**  
Polycarbonate  
Reflector

> 55x34mm

EAN		
5604612760816	1	100

ASRPC5535GR  
**Graphite**  
Polycarbonate  
Reflector

> 55x34mm

EAN		
5604612760809	1	100

## FIXED PC ROUND REFLECTOR TRIM

### Technical data:

- > GU10 light bulb not included
- > GU10 lamp holder not included
- > IP rating: IP20
- > Housing: polycarbonate
- > Insulation class: II
- > Flame retardant

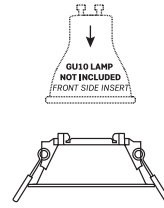

REF.	Colour	Dimensions				EAN
ASARPC875APR	●	85x36mm	75mm	1	100	5604612760229
ASARPC875ABR	○					5604612760212

## FIXED PC SQUARE REFLECTOR TRIM

### Technical data:

- > GU10 light bulb not included
- > GU10 lamp holder not included
- > IP rating: IP20
- > Housing: polycarbonate
- > Insulation class: II
- > Flame retardant

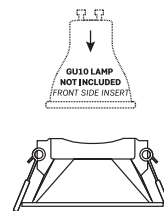

REF.	Colour	Dimensions				EAN
ASAQPC775APR	●	85x85x41mm	75x75mm	1	100	5604612760267
ASAQPC775ABR	○					5604612760250

## FIXED PC ROUND TRIM

### Technical data:

- > GU10 light bulb not included
- > GU10 lamp holder not included
- > IP rating: IP20
- > Housing: polycarbonate
- > Insulation class: II
- > Flame retardant

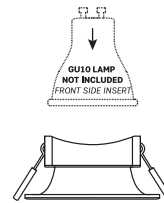

REF.	Colour	Dimensions				EAN
ASARPC1370APR	●	86x40mm	70~75mm	1	100	5604612760366
ASARPC1370ABR	○					5604612760359

## FIXED PC SQUARE TRIM

### Technical data:

- > GU10 light bulb not included
- > GU10 lamp holder not included
- > IP rating: IP20
- > Housing: polycarbonate
- > Insulation class: II
- > Flame retardant

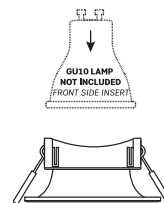

REF.	Colour	Dimensions				EAN
ASAQPC1370CPR	●	86x86x40mm	70~75mm	1	100	5604612760380
ASAQPC1370CBR	○					5604612760373



## FIXED PC ROUND TRIM

### Technical data:

- > GU10 light bulb not included
- > GU10 lamp holder not included
- > Índice de proteção: IP65
- > Housing: polycarbonate
- > Insulation class: II
- > Flame retardant

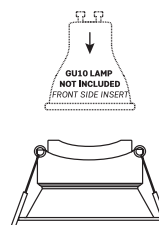

**IP65**



REF.	Colour	Dimensions				EAN
ASARPC2019PR	●	93x52mm	85mm	1	100	5604612760427
ASARPC2019BR	○					5604612760410

## FIXED PC SQUARE TRIM

### Technical data:

- > GU10 light bulb not included
- > GU10 lamp holder not included
- > Índice de proteção: IP65
- > Housing: polycarbonate
- > Insulation class: II
- > Flame retardant

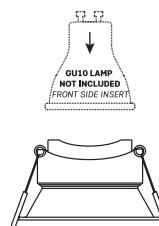

**IP65**



REF.	Colour	Dimensions				EAN
ASAQPC2019PR	●	93x93x52mm	85mm	1	100	5604612760397
ASAQPC2019BR	○					5604612760403

## FIXED PC TRIM WITH SILVER MIRRORED REFLECTOR

### Technical data:

- > GU10 light bulb not included
- > GU10 lamp holder not included
- > IP rating: IP20
- > Housing: polycarbonate
- > Insulation class: II
- > Flame retardant

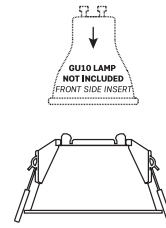

REF.	Colour	Dimensions	Hole			EAN
ASAQPC785ABP		93x93x53mm	85x85mm	1	100	5604612760274
ASARPC885ABP		93x53mm	85mm	1	100	5604612760281

## STRAIGHT SKIRT E27 LAMP HOLDER

### Technical data:

- > Max. 11W LED
- > Input voltage: 230V AC
- > IP rating: IP20
- > Housing: polypropylene (PP)



REF.	Colour	Dimensions			EAN
ASSBE27PR		135x49mm	1	60	5604612760441
ASSBE27BR					5604612760434

## LED MODULE 38°

### Technical data:

- > LED: SMD 2835
- > Beam angle: 38°
- > Input voltage: 200-240V AC
- > Frequency: 50-60Hz
- > Cri: >80
- > Service life: 25,000h
- > Switch cycles: 15,000
- > IP rating: IP20
- > Housing: Aluminium
- > Diffuser: polyamide (PA)



REF.	Dimensions	Power	Useful Lumens	3CCT			EAN
ASML7C3	50x38mm	7W	700LM <sup>360°</sup>	3000K-4000K-6000K	1	100	5604612758981

## DISPLAY BOX FOR TRIMS PC 6+1

### Composition:

- > 1 Trim - ASARPC375BR + ASRPC5535OR
- > 1 Trim - ASAQPC380PR + ASRPC5535GR
- > 1 Trim - ASARPC1775BR
- > 1 Trim - ASAQPC1370CBR
- > 1 Trim - ASARPC670PR
- > 1 Trim - ASARPC1370APR
- > 1 LED Module - ASML7C3



REF.	EAN
ASCEAPC61	5604612769116



## POWER STRIPS AND EXTENSION CORDS



### Power strip with USB A+C charger

ASLO's Power Strip with USB A+C Charger offers power and convenience in a single device, allowing you to power and charge multiple devices simultaneously.

Designed for those seeking organisation and power, this power strip is equipped with four Schuko 2P+E-16A sockets with protected receptacles and two USB A + C ports, ensuring greater safety and reducing the risk of electrical accidents.

The rated voltage of 230V ensures full compatibility with electrical installations, while the 1.4-metre cable offers flexibility in positioning.

With its robust construction and high-quality finish, this power strip is ideal for both domestic and professional use, ensuring stable power distribution and efficient device charging.

#### Main features:

- > 4 Schuko 2P+E-16A sockets with protected receptacles, ensuring greater safety.
- > USB A + C ports integrated into a charger, which can be used independently.
- > 1.4 metre cable for greater reach and flexibility of use.
- > Robust and secure design, ideal for domestic or professional environments.



ON/OFF switch



Incorporated charger



USB A + C ports

REF.	Dimensions (mm)		EAN
ASBT416USBAC	350 X 50 X 40	20	5604612766580



## Power cube

ASLO's Power Cube is indicated to connect and charge several devices simultaneously, ensuring safety, practicality, and efficiency.

The 230V rated voltage ensures full compatibility with electrical installations, while the 1.4-metre cable offers positioning flexibility.

### Main features:

- > Compact cube-shaped design that optimises space and facilitates access to sockets.
- > Versatility guaranteed by the three 16A Schuko sockets + three USB (2xA + 1xC) ports.
- > 1.4 metre cable for greater freedom of use.
- > IP20 rating.



USB ports  
(2xA + 1xC)

REF.	Dimensions (mm)	☐	EAN
ASBTC3USB	80 x 80 x 80	20	5604612766573



## Charger

ASLO's Charger 2xUSB-C offers efficient charging in any situation, ensuring that devices are always ready to use.

Designed to meet the demands of everyday life, this charger combines power and practicality with a compact and modern design.

With two USB-C ports, it allows you to charge two devices simultaneously, ensuring practicality and convenience.

In addition, the maximum power of 17W ensures efficient charging, ideal for smartphones, tablets, and other devices compatible with the 230V voltage.

Made of resistant ABS, the charger has high durability and safety, even with frequent use.

### Main features:

- > Optimised charging, due to the two USB-C ports.
- > Maximum power of 17W, allowing you to charge devices efficiently.
- > Durable ABS body, prepared for intensive use.
- > Compact design, ideal for transport and use in any environment.



2 USB-C ports

REF.	Dimensions (mm)	☐	EAN
ASCUSB2C	70 X 50 X 40	20	5604612766559



## Travel extension cord

ASLO's Travel Extension Cord is a practical and safe solution for connecting and charging multiple devices simultaneously, ensuring power is always at hand.

Designed to keep up with the pace of those who travel frequently, this extension cord has a compact format that is easy to carry.

With one 2P+T socket (16A) and three USB ports (2x USB-C + 1xA), it allows you to simultaneously charge smartphones, tablets and other devices without the need for additional adapters.

### Main features:

- > Versatility by including one 2P + T socket and three USB (2xC + 1xA) ports.
- > High power of 3680W, ideal for powering multiple devices safely.
- > Greater range and flexibility, thanks to the 1.4-metre cable.
- > Robust ABS construction, ensuring resistance to impacts and overheating.



Robust ABS construction

REF.	Dimensions (mm)	☐	EAN
ASEV2USBC	130 x 70 x 60	20	5604612766566

## LXE SERIES LED WATERPROOF FIXTURE\*

ASLO's LED Waterproof Fixture provides long-lasting and efficient lighting, whether indoors or outdoors. With a colour temperature selector with 3 CCTs (3000K, 4000K and 6500K), you can easily adjust the light tone, adapting it to the different needs of each space. This surface-mounted LED luminaire can be mounted on either the wall or ceiling, reinforcing its versatile nature. In addition, the 120° beam angle ensures wide and uniform light distribution, making it ideal for work areas, garages, warehouses, or outdoor areas. Thanks to its IP65 protection rating and IK08 impact resistance, this fixture offers high protection against dust, moisture, and shocks, ensuring reliable performance even in demanding environments. In addition, the 25,000-hour service life and insulation class II reinforce its durability and safety.

### Main features:

- Adjustable lighting, thanks to the temperature selector with 3 CCTs for different environments;
- IP65 and IK08 protection ratings, ideal for spaces exposed to moisture and dust;
- Versatile installation, can be mounted on the wall or ceiling, indoors or outdoors;
- 120° beam angle ensures uniform light distribution;
- 25,000-hour service life and insulation class II for greater safety.



### Main features:

- > Efficiency: 110Lm/W
- > Rated voltage: 220-240V AC
- > Frequency: 50-60Hz
- > LED: SMD 2835
- > Beam angle: 120°
- > 3-CCT: 3000K-4000K-6500K
- > IP rating: IP65
- > IK rating: IK08
- > Housing: Polycarbonate (PC)
- > Operating temperature: -20° to +40°C
- > Driver: DOB
- > Service life: 25.000h
- > Switch cycles: 15.000
- > Insulation class: II



Cage clamp connector



Colour temperature selector



Cable gland (allows continuous connection)

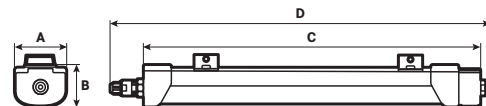

### Installation type:



Surface-mounted



Suspended (optional)



Continuous connection (optional)

REF.	Colour	W	Useful lumens	CRI	A	B	C	D			EAN
ASLXE18C3	○	18	1980Lm <sup>360°</sup>	80	65mm	51mm	505mm	600mm	1	30	5604612762636
ASLXE36C3	○	36	3960Lm <sup>360°</sup>	80	65mm	51mm	1105mm	1200mm	1	30	5604612762643
ASLXE48C3	○	48	5280Lm <sup>360°</sup>	80	65mm	51mm	1405mm	1500mm	1	30	5604612762650

\*This product contains a light source with energy efficiency class "E".

# Aslo

BRIGHTER LIFE



 **PORT** SERIES  
**PORTABLE RECHARGEABLE  
FLOODLIGHT**

# PORT SERIES

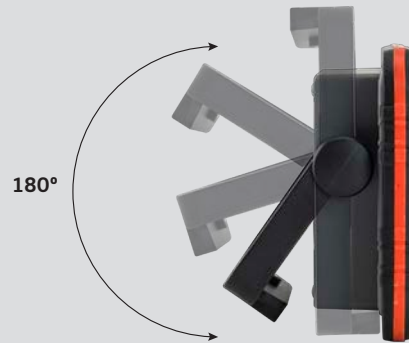

USB-C port



Magnetic base and adapter for installation on tripod

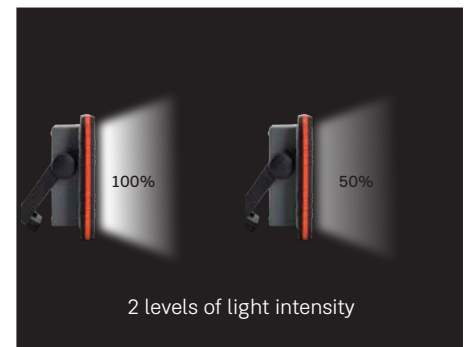

2 levels of light intensity

ASLO's 10W Portable Rechargeable Floodlight is a powerful and mobile lighting solution, ideal for indoor or outdoor work. This floodlight has been developed to provide practical lighting, even in the most demanding conditions. With a power of 10W and a luminous flux of 700 lumens, it offers a neutral light of 4000K that ensures clear and comfortable visibility in several types of environments. The rechargeable lithium-ion battery (4000mAh) offers up to 5 hours of autonomy and can be easily charged via the USB-C port. In addition, it features an On/Off switch and an operating mode with two intensity levels (100% and 50%) that allows you to adjust the light, while the adjustable bracket makes it easy to position the floodlight at different angles. With a service life of up to 25,000 hours, IP54 protection rating and IK06 impact resistance, the floodlight is robust, dust-resistant and splash-proof.

## Main features:

- Powerful and efficient, with a neutral 4000K light;
- Rechargeable battery, ensuring total mobility and convenience;
- On/Off switch for greater control of the luminaire;
- Versatility ensured by adjustable light mode (100% / 50%) and adjustable bracket;
- IP54 and IK06 ratings for safe use in indoor and outdoor environments;
- Long service life with up to 25,000 hours of use.

## Portable Rechargeable Floodlight



### Floodlight:

- > Efficiency: 70Lm/W
- > Input USB-C: 5 Vdc - 1A
- > Rated output current: 4000mAh
- > LED: SMD 2835
- > Driver: DOB
- > Beam angle: 120°
- > Housing: Polyamide (PA)
- > Diffuser: Polycarbonate (PC) - opaline

- > Operating temperature: -20° to +40°C
- > Insulation class:  $\text{II}$

### Battery:

- > Lithium-ion battery 18650, 2 x 3,7 Vdc
- > Charging time: 5h
- > Autonomy: 5h- max.
- > Switch cycles: 300



USB-C adapter included



Mode switch

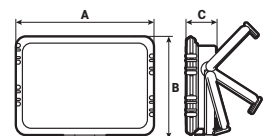

REF.	Colour	W	Lumens	CCT	CRI	A	B	C			EAN	
ASPORT1040	●●	10	700Lm	○	4000K	80	155mm	107mm	35mm	1	20	5604612762674

# Aslo

BRIGHTER LIFE



**PRO SERIES  
PORTABLE FLOODLIGHT  
WITH SOCKET 2P+E**

## PRO SERIES

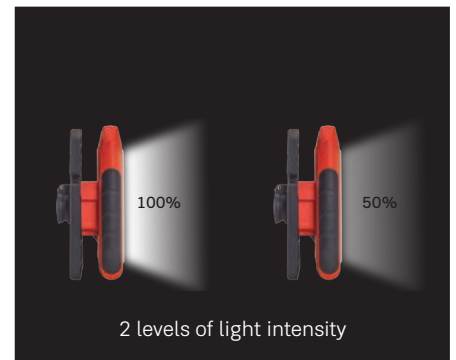

ASLO's 30W Portable Floodlight is a powerful and mobile lighting solution, ideal for indoor or outdoor work.

Designed to provide practical lighting, this floodlight has an LED light source with a luminous flux of 2550 lumens and a neutral light of 4000K, offering high visibility even in the most demanding conditions.

Made of PA (polyamide) and PC (polycarbonate), this luminaire offers high impact resistance, good thermal stability and excellent resistance to weathering and UV radiation.

In addition, it features an On/Off switch and an operating mode with two intensity levels (100% and 50%) that allows you to adjust the light, while the adjustable bracket makes it easy to position the floodlight at different angles.

Equipped with a Schuko 2P+E 230V socket and a 3-metre H07RN-F 3G1,0mm<sup>2</sup> power cord, it allows you to conveniently connect to any device. In addition, the service life of up to 25,000 hours, IP54 rating and IK06 impact resistance ensure robustness, dust, and splash resistance, while Class II insulation ensures greater electrical safety, eliminating the need for earthing and reducing the risk of electric shock.

### Main features:

- Powerful and efficient, with a luminous flux of 2550 lumens;
- Neutral and comfortable lighting with 4000K;
- Manufactured in PA and PC, ensuring thermal stability and resistance to weather conditions;
- On/Off switch for greater control of the luminaire;
- Versatility ensured by two light intensity levels and an adjustable bracket;
- Schuko 2P+E socket - 230V for connection to any device;
- IP54 and IK06 ratings for safe use in indoor and outdoor environments.
- Class II insulation for greater electrical safety;
- Long service life with up to 25,000 hours of use.



### Portable floodlight with socket 2P+E\*



#### Main features:

- > Efficiency: 85Lm/W
- > Rated voltage: 220-240V AC
- > Frequency: 50-60Hz
- > LED: SMD 2835
- > Driver: DOB
- > Beam angle: 120°
- > Housing: Polyamide (PA)
- > Diffuser: Polycarbonate (PC)
- > Operating temperature: -20° to +40°C
- > Service life: 25.000h
- > Switch cycles: 15.000
- > IP rating: IP54
- > IK rating: IK06
- > Cable: 3G1,0mm<sup>2</sup> H07RN-F - 3m
- > Outputs: 1 Socket 2P+E
- > Insulation class: II

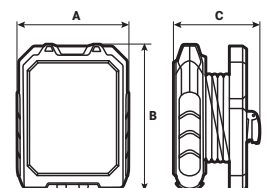

REF.	Colour	W	Useful lumens	CCT	CRI	A	B	C	⊠	⊞	EAN
ASPRO3040	● ●	30	2550Lm <sup>120°</sup>	○	4000K	80	169mm	232mm	103mm	1 10	5604612762667

\*This product contains a light source with energy efficiency class "F".

# Aslo

BRIGHTER LIFE

## PUSH-DIM DALI DRIVER

ACCESSORIES AND CONSUMABLES



### Push-DIM DALI driver



#### Technical data:

- > Maximum supported power: 40W
- > Input voltage: 200-240V AC
- > Output voltage: 24-42V dc
- > Output current: 1050mA
- > Interfaces: DALI / PUSH
- > The 10-level current output can be set using a 'DIP switch'
- > Smooth, flicker-free regulation at any brightness
- > High efficiency and low THD
- > Insulation class II
- > IP rating: IP20

#### Functions:

- > Supports DALI-2 + PUSH DIM dimming mode.
- > Supports central emergency application (normal dimming at DC input)
- > Supports standalone emergency applications
- > Protection features (against short circuits, no load, hot connection)
- > The interfaces: DALI/PUSH are modern lighting control systems, home automation and energy efficiency projects that require fixed light dimming

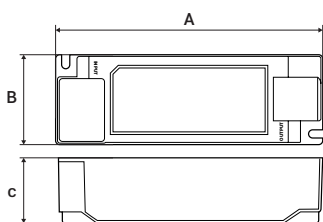

REF.	A	B	C			EAN
ASDLPDD40	137mm	46mm	30mm	1	100	5604612768157

This accessory is a good complement to ASLO's range of LED panel lights:

#### Backlight day Series



Square LED Panel Light



Rectangular LED Panel Light



Search pages: 34 and 35  
learn more:  
'ASLO Lighting Catalogue'

## Input parameters

Rated input voltage	200-240V AC
Input current	<0.23A (Rated input voltage)
Frequency	50-60Hz
Power factor (P.F)	0.97
Mismatch factor (D.F)	0.98
Peak current	14,75A
On / Switch / Off	<0.7s (AC on) <0.7s (DC on) <0.3s (AC/DC switch) <0.5s (off)
Switch cycles:	50,000

## Output parameters

Dimming method	Constant current
Rated output current	0.6-1.05A
Output voltage	24-38 / 40 / 42VDC
Maximum power	40W
Output current adjustment	DIP S.W (10 levels)
Output current	1050mA
No-load output voltage	50VDC
Consumption	44,9W
Maximum voltage	I/P-O/P(LED):3750V AC, I/P-DALI: 1500V AC, O/P-DALI: 1500V AC

## Control interface

DALI dimming port	Voltage range: 9,5-22,5 V, typical 16 V, interface current consumption: 1,8 mA
Push DIM dimming port	180-264V 47/63Hz
Dimming control mode	AM (amplitude modulation)

## Emergency support

Central emergency system	Supported (normal dimming at DC input)
Self-contained emergency	Supported

## Environment and service life

Operating temperature	-20-45°
Humidity	5-85% RH
IP rating	IP20
Service life	100.000 h

## Certifications and Standards

Certifications	CE, ENEC, UKCA, RCM, CCC, EL, DALI-2
DALI-2	IEC 62386-101 (DALI-2), IEC 62386-102 (DALI-2), IEC 62386-207 (DALI-2)

# Aslo

BRIGHTER LIFE

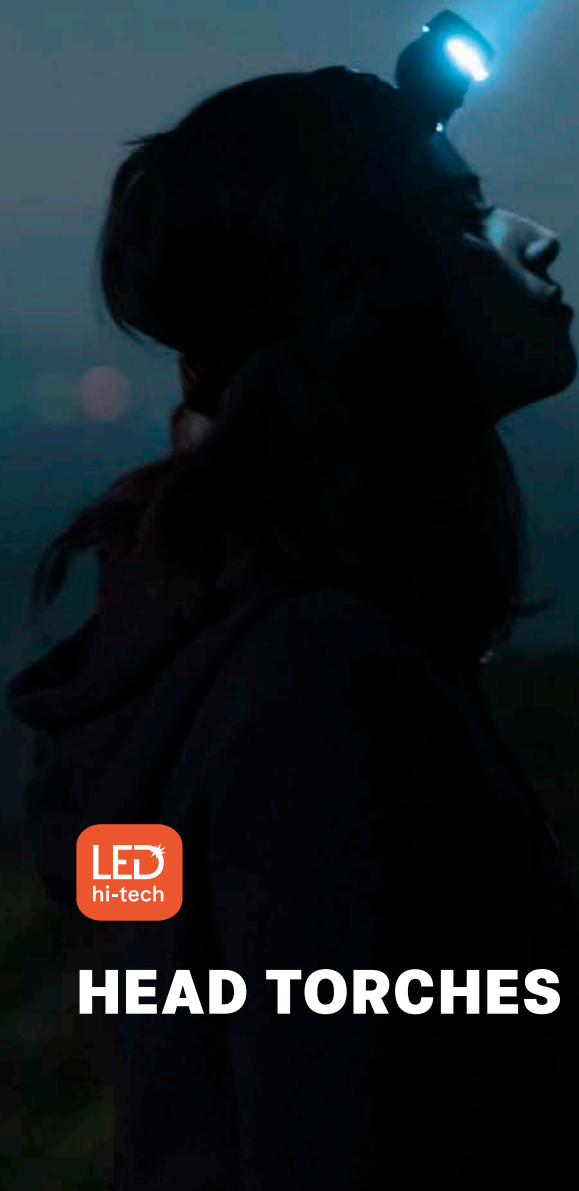

**HEAD TORCHES**

aslo.pt

## COB head torch

3W | 3 x AAA

**Technical data:**

- > Type of lighting: LED'ON, MAX, Flash and Red Light
- > High/low/strobe COB; red high/strobe LED
- > Beam angle range: 20m
- > Rotation: 180°
- > Power supply: 3xAAA (batteries included)
- > Housing: ABS/rubber
- > Waterproof
- > Contains display box



Rotation 180°



Red Light



3 batteries AAA included

REF.	Power	Lumens			EAN
ASLCCOB3	3W	180Lm	12	48	5604612763848

## Rechargeable dual head torch

5W + 3W

**Technical data:**

- > Type of lighting: LED'ON, MAX and Flash
- > High/low COB; high/strobe LED
- > COB beam angle range: 20m
- > LED beam angle range: 80m
- > Power supply: USB-C cable (included)
- > Lithium-ion battery: 1200mAh
- > Housing: ABS/rubber
- > Lightweight and adjustable
- > Waterproof
- > Contains display box



Motion sensor



Two light sources: COB and LED



Cable USB-C included

REF.	Power (COB / LED)	Lumens (COB / LED)			EAN
ASLCDR53	5W / 3W	350Lm / 120Lm	12	48	5604612763862

## Rechargeable head torch with sensor

3W

**Technical data:**

- > Type of lighting: LED'ON, MAX, Flash and Red Light
- > White and red high/low/strobe LED
- > Beam angle range: 100m
- > Power supply: USB-C cable (included)
- > Lithium-ion battery: 1200mAh
- > Housing: ABS/rubber
- > Lightweight and adjustable
- > Waterproof
- > Contains display box



Motion sensor

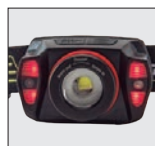

Red Light



Cable USB-C included

REF.	Power	Lumens			EAN
ASLCRS3	3W	300Lm	12	48	5604612763855

## 3-WAY ADAPTER

INDUSTRIAL



### Main features:

- > Versatility by combining three three-phase outputs 2x3P+T and 1x3P+T+N.
- > IP44 rating for protection against dust and splashes, ideal for indoor and outdoor use.
- > 2m cable for mobility.
- > Durable thermoplastic body, suitable for demanding environments.
- > Compact dimensions and portable installation.

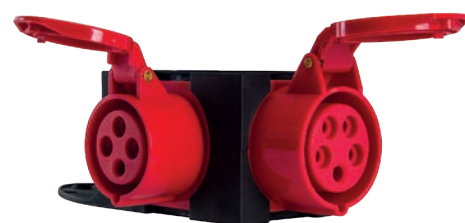

### Technical data:

Type:	CEE - Three-phase
Number of poles:	2 Female x 3P+T 1 Female x 3P+T+N
Rated current:	16A
Cable:	H07RN-F
Cable length:	2M
Section:	5G2,5mm <sup>2</sup>
Voltage:	380-415V AC 50-60Hz
Male plug:	3P+T+N - 16A
IP rating:	IP44
Standards:	CE RoHs



REF.			AxBxC				EAN.
ASAT314315C2	2	1	165x240x80mm	1,600 kg	1	6	5604612762322

# Aslo

BRIGHTER LIFE

**PROFILES & ACCESSORIES**

LED Strips

aslo.pt

## U-shaped aluminium profile Surface-mounted - Anodized



**Technical data:**

- > Surface-mounted
- > High-resistance to corrosion
- > Good conformability
- > Medium mechanical resistance
- > Diffuser: Polycarbonate (PC)

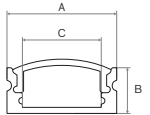

Reference	Colour	Length	A	B	C			Ean
ASPAS177	●	2 metres	17mm	7mm	12mm	1	60	5604612699666

## U-shaped aluminium profile Surface-mounted - White

**NOVO**



**Technical data:**

- > Surface-mounted
- > High-resistance to corrosion
- > Good conformability
- > Medium mechanical resistance
- > Diffuser: Polycarbonate (PC)

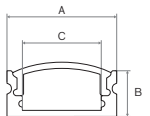

Reference	Colour	Length	A	B	C			Ean
ASPAS177BR	○	2 metres	17mm	7mm	12mm	1	60	5604612762377

## U-shaped aluminium profile Surface-mounted

**NOVO**



**Technical data:**

- > Recessed mounting
- > High-resistance to corrosion
- > Good conformability
- > Medium mechanical resistance
- > Diffuser: Polycarbonate (PC)

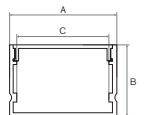

Reference	Colour	Length	A	B	C			Ean
ASPAS3020	●	2 metres	30mm	20mm	25mm	1	20	5604612762391

## Aluminium profile Angular



**Technical data:**

- > 90° angle mounting
- > High-resistance to corrosion
- > Good conformability
- > Medium mechanical resistance
- > Diffuser: Polycarbonate (PC)

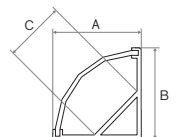

Reference	Colour	Length	A	B	C			Ean
ASPAA155	●	2 metres	15,5mm	15,5mm	10,5mm	1	60	5604612699680



## Plaster-in aluminium profile Recessed

**NOVO**

**Technical data:**

- > Recessed mounting
- > High-resistance to corrosion

- > Good conformability
- > Medium mechanical resistance
- > Diffuser: Polycarbonate (PC)

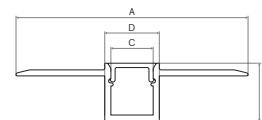

Reference	Length	A	B	C	D			Ean
ASPAP5213	2 metres	52mm	13mm	10mm	12mm	1	40	5604612762346
ASPAP6114	2 metres	61mm	14mm	21mm	28mm	1	25	5604612762339



## U-shaped aluminium profile Recessed - Anodized

**Technical data:**

- > Recessed mounting
- > High-resistance to corrosion

- > Good conformability
- > Medium mechanical resistance
- > Diffuser: Polycarbonate (PC)

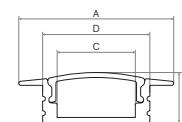

Reference	Colour	Length	A	B	C	D			Ean
ASPAP247	●	2 metres	24mm	7mm	12mm	17mm	1	60	5604612699673



## U-shaped aluminium profile Recessed - White

**NOVO**

**Technical data:**

- > Recessed mounting
- > High-resistance to corrosion

- > Good conformability
- > Medium mechanical resistance
- > Diffuser: Polycarbonate (PC)

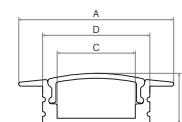

Reference	Colour	Length	A	B	C	D			Ean
ASPAP247BR	○	2 metres	24mm	7mm	12mm	17mm	1	60	5604612762353



## U-shaped aluminium profile Recessed

**NOVO**

**Technical data:**

- > Recessed mounting
- > High-resistance to corrosion

- > Good conformability
- > Medium mechanical resistance
- > Diffuser: Polycarbonate (PC)

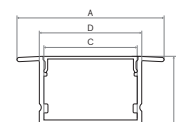

Reference	Length	A	B	C	D			Ean
ASPAP4320	2 metres	43mm	20mm	27mm	30mm	1	20	5604612762421

## Accessories for U-shaped aluminium profile Surface-mounted



Reference	ASTFPAS177	<b>NEW</b> ASTFPAS177BR	ASCFPAS177
Designation	End cap for U-shaped aluminium profile	End cap for for aluminium profile	Mounting clip for U-shaped aluminium
Dimensions	17x7mm	17x7mm	17x7mm

## Accessories for U-shaped aluminium profile Surface-mounted



Reference	<b>NEW</b> ASTFPAS3020	<b>NEW</b> ASCFPAS3020
Designation	End cap for for aluminium profile	Mounting clip for aluminium profile
Dimensions	30x20mm	30x20mm

## Accessories for aluminium profile Angular



Reference	ASTFPAA155	ASCFPAA155	ASUAPAA155
Designation	End cap for for angular aluminium profile	Mounting clip for angular aluminium profile	Connector for angular aluminium profile
Dimensions	15,5x15,5mm	15,5x15,5mm	15,5x15,5mm

## Accessories for aluminium profile Plaster-in recessed



Reference	<b>NEW</b> ASTFPAP5213	<b>NEW</b> STFPAP6114
Designation	End cap for for aluminium profile	End cap for for aluminium profile
Dimensions	52x13mm	61x14mm

## Accessories for U-shaped aluminium profile Recessed



Reference	ASTFPAE247	<b>NEW</b> ASTFPAE247BR	ASCFPAE247
Designation	End cap for U-shaped aluminium profile	End cap for for aluminium profile	Mounting clip for U-shaped aluminium profile
Dimensions	24x7mm	24x7mm	24x7mm

## Accessories for U-shaped aluminium profile Recessed



Reference	<b>NEW</b> ASTFPAE4320	<b>NEW</b> ASCFPAE4320
Designation	End cap for for aluminium profile	Mounting clip for aluminium profile
Dimensions	43x20mm	43x20mm

## FIT Series LED FIXTURES

Indoor Lighting



**Technical data:**

- > LED: SMD 2835
- > 3 CCT: 3000K, 4000K and 6500K
- > Beam angle: 120°
- > Input voltage: 175 - 265V AC
- > Frequency: 50-60Hz
- > Service life: 25.000h
- > Switch cycles: 15.000
- > Colour rendering index: >80
- > IP rating: IP30
- > Base: polycarbonate (PC)
- > Diffuser: polycarbonate (PC)
- > Operating temperature: -20° to 40°C
- > Energy rating: F
- > Insulation class: II

ASLO's LED Fixtures from the FIT Series provide versatility by allowing you to select between three colour temperatures (3000K, 4000K and 6500K), adapting to any space. The optimised design ensures broad and uniform lighting, while the polycarbonate construction ensures durability, even in demanding environments. With a long service life and low consumption due to the efficiency of LED lighting, it is a practical and reliable solution for both residential and professional contexts.



CCT selector  
(3000K-4000K-  
6500K)



Input connector



Accessories included

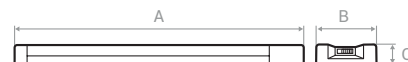

Reference	Colour	Power	Useful lumens	Mismatch factor	Output current	A	B	C			Ean
ASFIT20C3	○	20W	1990Lm <sup>360°</sup>	<0,5	120mA	600mm	70mm	30mm	1	20	5604612754846
ASFIT30C3	○	30W	2900Lm <sup>360°</sup>	<0,9	190mA	900mm	70mm	30mm	1	20	5604612754853
ASFIT40C3	○	40W	4150Lm <sup>360°</sup>	<0,9	230mA	1200mm	70mm	30mm	1	20	5604612754860

# Aslo

BRIGHTER LIFE

NAV and FLAT series  
**PANEL LIGHTS**

Indoor Lighting

aslo.pt

LED  
hi-tech

## NAV Series

- Service life: 25.000h ○ Switch cycles: 15.000 ○ LED: SMD 2835
- IP rating: IP44 ○ Installation: recessed or surface-mounted

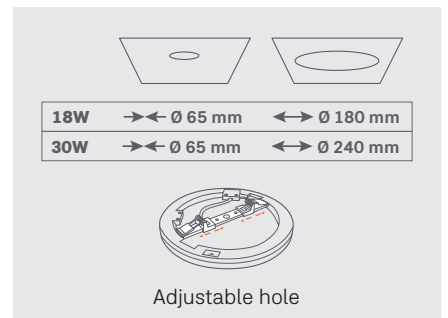
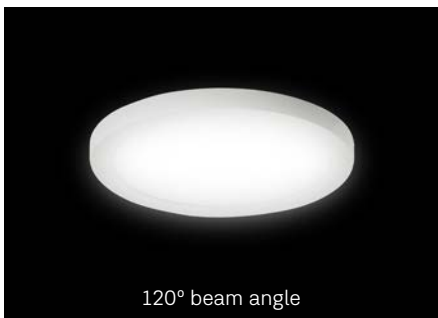

## Adjustable round panel light

### Technical data:

- > LED: SMD 2835
- > 3CCT: 3000K, 4000K and 6500K
- > Beam angle: 120°
- > Input voltage: 220-240V AC
- > Frequency: 50-60Hz
- > Service life: 25.000h
- > Switch cycles: 15.000
- > IP rating: IP44
- > Housing: polypropylene (PP)
- > Diffuser: polystyrene (PS)
- > Operating temperature: -20° to 45°C
- > Insulation class: II



Flexible fitting



Colour temperature selector

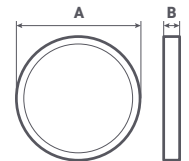

Reference	Colour	Power	Useful lumens	Total lumens	CRI	D.F.	A	B			EAN
ASNAV18C3	○	18W	1880Lm <sup>360°</sup>	1510Lm	80	0,70	225mm	17mm	1	20	5604612759711
ASNAV30C3	○	30W	3300Lm <sup>360°</sup>	1920Lm	80	0,90	300mm	17mm	1	10	5604612759728



### ACCESSORIES FOR NAV PANEL LIGHTS (NOT INCLUDED)

ASAMNAV18PR  
**Metal frame for NAV panel light**  
**Black**

- > 18W
- > 225 x 18 mm

EAN

5604612759759      1      20

ASAMNAV18NS  
**Metal frame for NAV panel light**  
**Satin nickel**

- > 18W
- > 225 x 18 mm

EAN

5604612759766      1      20

ASAMNAV30PR  
**Metal frame for NAV panel light**  
**Black**

- > 30W
- > 300 x 18 mm

EAN

5604612759780      1      10

ASAMNAV30NS  
**Metal frame for NAV panel light**  
**Satin nickel**

- > 30W
- > 300 x 18 mm

EAN

5604612759773      1      10

## FLAT Series

- Service life: 25.000h ○ Switch cycles: 15.000 ○ LED: SMD 2835
- IP rating: IP20 ○ Installation: surface-mounted or suspended

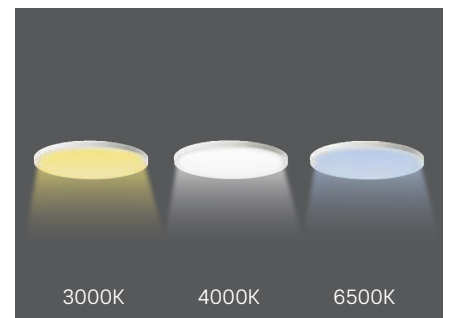
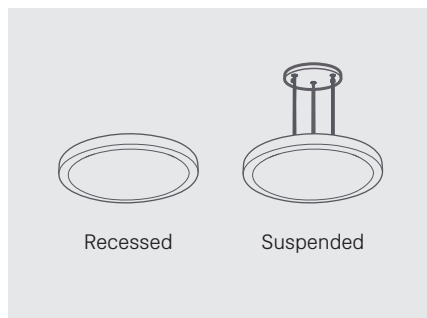
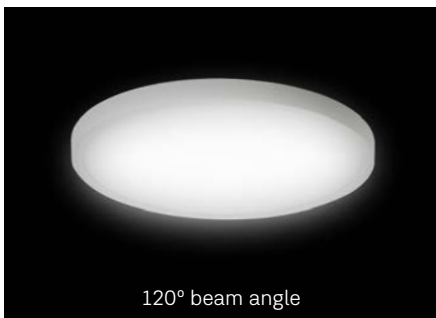

## Round panel light

### Technical data:

- > LED: SMD 2835
- > 3CCT: 3000K, 4000K and 6500K
- > Beam angle: 120°
- > Input voltage: 220-240V AC
- > Frequency: 50-60Hz
- > Service life: 25,000h
- > Switch cycles: 15,000
- > IP rating: IP20
- > Housing: polypropylene (PP)
- > Diffuser: polystyrene (PS)
- > Operating temperature: -20° to 45°C
- > Insulation class: II



Quick connector



Power and colour temperature selector

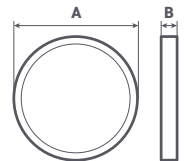

Reference	Colour	Power	Useful lumens	Total lumens	CRI	D.F.	A	B			EAN
ASFLAT36C3	○	36-30-24W	4080Lm <sup>360°</sup>	36W=2860Lm	80	0,90	400mm	25mm	1	10	5604612759735
ASFLAT50C3	○	50-45-40W	5500Lm <sup>360°</sup>	50W=3710Lm	80	0,90	600mm	28mm	1	5	5604612759742



### ACCESSORIES FOR FLAT PANEL LIGHTS (NOT INCLUDED)

**ASCSFLAT**  
**Suspension kit for FLAT**  
**panel light**  
**White**

- > IP20
- > Base: Iron
- > 200~1200 x 20 mm



**EAN**

5604612759797      1      72



# Aslo

BRIGHTER LIFE

## LED fridge bulb





E14 | 30.000h

Highly efficient and long-lasting, LED technology is also environmentally friendly. Its versatility (due to the diversity of solutions it offers) allows you to further explore the environment that surrounds you and with which you interact on a daily basis. This is the most effective and long-lasting choice, without compromising light quality or stifling imagination. And the environment will thank you for it!

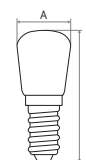
### Technical data:

- > LED: SMD 5050
- > Beam angle: 270°
- > Switch cycles: 50.000
- > Non-dimmable
- > Input voltage: 220-240V AC
- > Frequency: 50-60Hz
- > Housing: glass



REF.	Power	Lumens	CCT	CRI	A	B			EAN
ASLEDFRI1827BL	1,8W	180Lm <sup>360°</sup>	 2700K	80	22mm	50mm	20	200	5604612676179
ASLEDFRI1865BL <b>NEW</b>	1,8W	180Lm <sup>360°</sup>	 6500K	80	22mm	50mm	20	200	5604612759940

# Aslo

BRIGHTER LIFE

**LED STRIP REEL**  
AND ACCESSORIES

[aslo.pt](http://aslo.pt)



# LED STRIP REEL

7W

> ASLO's LED Strip Reel represents a practical and versatile lighting solution. This product can be used as a light source in a variety of domestic, professional, or industrial contexts.

**Technical data:**

- > Supply voltage: 230V AC
- > Frequency: 50-60Hz
- > Beam angle: 120°
- > CCT: 4000K
- > Service life: 30.000h
- > Switch cycles: 15.000
- > IP rating: IP65
- > Strip material: PVC
- > Operating temperature: -10° to +40°C
- > Insulation class: II
- > Cable: H05RN-F 3G0,75mm<sup>2</sup> - 3m



## LED strip reel - 7W 230V | IP65



**Technical data:**

- > LED: 120 SMD 2835/m
- > Useful lumens: 590Lm/m<sup>360</sup>
- > Cut: 1000mm

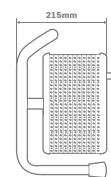
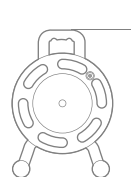
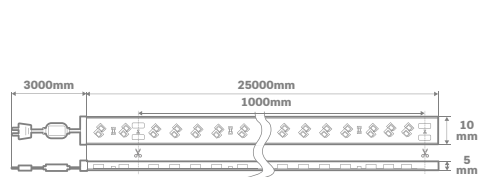

REF.	Rollo	PCB	Watts	CRI			EAN
ASFLE23074025	25 metres	10mm	7W/m	80	1	1	5604612752040

## Accessories for LED strip reel 10 MM | 230V



ASTSFL10230



ASCFFL10230



ASLFL10230



ASUFL10230



ASCAFL10230

REF.	Description			EAN
ASTSFL10230 <b>NEW</b>	Silicone end cap	25	500	5604612763558
ASCFFL10230 <b>NEW</b>	Mounting clip	25	500	5604612763565
ASLFL10230 <b>NEW</b>	2-pin connector	25	500	5604612763541
ASUFL10230 <b>NEW</b>	2-pin in-line connector	25	500	5604612763572
ASCAFL10230 <b>NEW</b>	Power cable (Max. 30 m)	1	250	5604612763534

## T5 FIXTURES

Indoor Lighting



### Technical data:

- > LED: SMD 2835
- > 3 CCT: 3000K, 4000K and 6500K
- > Beam angle: 120°
- > Input voltage: 230V AC
- > Frequency: 50-60Hz
- > Service life: 25,000h
- > Switch cycles: 15,000
- > Colour rendering index: 80
- > IP rating: IP20
- > Base: polycarbonate (PC)
- > Diffuser: polycarbonate (PC)
- > Operating temperature: -20° to 45°C
- > Energy rating: F
- > Insulation class: II

To interconnect several devices, use the connector in direct mode or use the connection cable that must be purchased separately (ASCL2050T5). Connect the first luminaire of the series using

the 1.5 m connector supplied. Fixtures of different power ratings can be connected to each other. Total power should not exceed 220W.



CCT selector (3000K - 4000K - 6500K)



Operating mode selector



Allows continuous connection



Accessories included

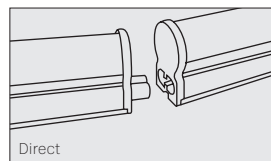

Direct

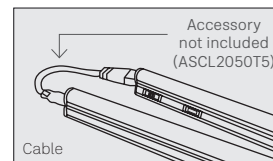

Cable

Accessory not included (ASCL2050T5)



Reference	Max. fixtures in continuous connection	Colour	Power	Useful lumens	Mismatch factor	Output current	A	B	C			Ean
ASALT5P5C3	20	○	5W	450Lm <sup>360°</sup>	<0,5	40mA	300mm	34mm	23mm	1	25	5604612754877
ASALT5P9C3	11	○	9W	850Lm <sup>360°</sup>	<0,5	72mA	572mm	34mm	23mm	1	25	5604612754884
ASALT5P12C3	85	○	12W	1200Lm <sup>360°</sup>	<0,7	95mA	880mm	34mm	23mm	1	25	5604612754891
ASALT5P18C3	5	○	18W	1800Lm <sup>360°</sup>	<0,7	145mA	1178mm	34mm	23mm	1	25	5604612754907
ASALT5P22C3	4	○	22W	2200Lm <sup>360°</sup>	<0,7	175mA	1478mm	34mm	23mm	1	25	5604612754914

### ACCESSORIES FOR T5 FIXTURES

#### Connection cable m/f 2x0.50mm



Reference	Dimension			Ean
ASCL2050T5	150 mm	100	500	5604612754792

# Aslo

BRIGHTER LIFE

## CIRCLE Series CEILING LIGHTS

Indoor Lighting

[aslo.pt](http://aslo.pt)

## CIRCLE Series

- Service life: 50,000h
- Switch cycles: 25,000
- Dimmable: TRIAC
- IP rating: IP44

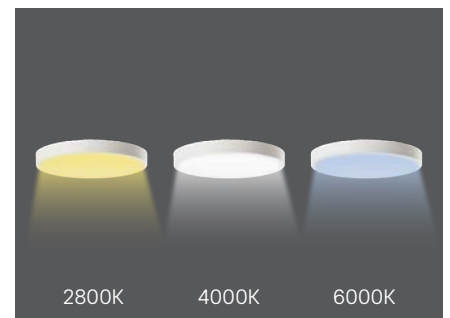
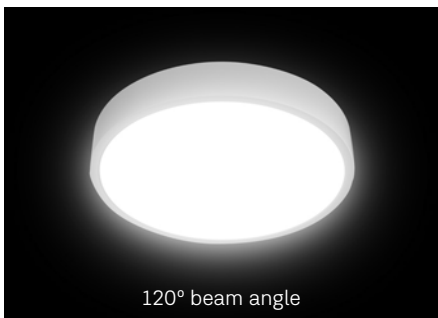

### Technical data:

- > LED: SMD 2835
- > 3CCT: 2800K, 4000K and 6000K
- > Regulation: TRIAC
- > Beam angle: 120°
- > Input voltage: 220-240V AC
- > Frequency: 50-60Hz
- > Service life: 50,000 h
- > Switch cycles: 25,000
- > Mismatch factor: <0,9
- > IP rating: IP44
- > Housing: ABS
- > Diffuser: polystyrene (PS)
- > Operating temperature: -20° to 45°C
- > Insulation class: II

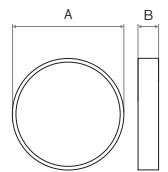

Reference	Colour	Power	Lumens	CRI	A	B			Ean
ASCIR18C3BR	○	18W	1700Lm <sup>360°</sup>	90	230mm	45mm	1	28	5604612759629
ASCIR18C3PR	●	18W	1700Lm <sup>360°</sup>	90	230mm	45mm	1	28	5604612759636
ASCIR24C3BR	○	24W	2350Lm <sup>360°</sup>	90	300mm	45mm	1	20	5604612759650
ASCIR24C3PR	●	24W	2350Lm <sup>360°</sup>	90	300mm	45mm	1	20	5604612759643
ASCIR32C3BR	○	32W	3100Lm <sup>360°</sup>	90	400mm	45mm	1	10	5604612759667
ASCIR32C3PR	●	32W	3100Lm <sup>360°</sup>	90	400mm	45mm	1	10	5604612759674

### ACCESSORIES FOR CEILING LIGHTS

<b>ASDL18CIR Driver LED 18W</b> > 220-240VAC / 120-130VDC > 120mA  <b>Ean</b> 5604612760731	<b>ASDL24CIR Driver LED 24W</b> > 220-240VAC / 120-130VDC > 160mA  <b>Ean</b> 5604612760755	<b>ASDL32CIR Driver LED 32W</b> > 220-240VAC / 120-130VDC > 230mA  <b>Ean</b> 5604612760779	<b>ASCL18CIRCC3 Chip LED 18W</b>  > D200mm > SMD2835 > 110Lm <b>Ean</b> 5604612760748	<b>ASCL24CIRCC3 Chip LED 24W</b>  > D275mm > SMD2835 > 110Lm <b>Ean</b> 5604612760762	<b>ASCL32CIRCC3 Chip LED 32W</b>  > D350mm > SMD2835 > 110Lm <b>Ean</b> 5604612760786
--	--	--	---	---	---

## ACCESSORIES FOR TRACK LIGHTS

Three-phase track for installation of ASLO's LIVING and LOUNGE series spotlights. Possibility of connecting several track spotlights on the same rail, allowing the control of 3 independent lighting circuits. Available in surface mounted / suspended and recessed versions and in white and black, it already includes the feed-in and end cap. Several connection accessories available.

### > SURFACE MOUNTED

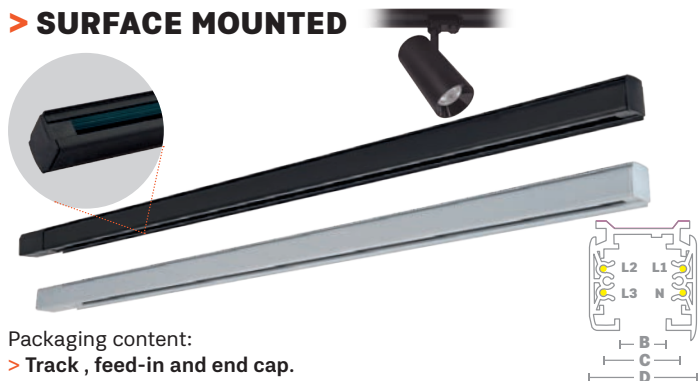

Packaging content:  
> Track , feed-in and end cap.

### 3-CIRCUIT SURFACE MOUNTED TRACK\*

REF.	COLOUR	AxBxCxD	m	Box	EAN.
ASCS3C2BR	○	32,6x14,5x22x32,2 mm	2	1	5604612723606
ASCS3C2PR	●				5604612723637
ASCS3C3BR	○		3	1	5604612723613
ASCS3C3PR	●				5604612723620

\* Track spot light not included.



### FEED-IN FOR 3-CIRCUIT SURFACE MOUNTED TRACK

REF.	COLOUR	AxBxC	Box	EAN.
ASACS3CBR	○	32x25,5x98,5 mm	1	5604612723682
ASACS3CPR	●		1	5604612723699



### ROUND BASE FOR 3-CIRCUIT SURFACE MOUNTED TRACK LIGHT

REF.	COLOUR	AxØ	Box	EAN.
ASBCS3CBR	○	32x100 mm	1	5604612723743
ASBCS3CPR	●		1	5604612723750



### SUSPENSION KIT FOR SURFACE MOUNTED TRACK

REF.	COLOUR	AxBxCxD	Box	EAN.
ASCS3C3BR	○	33x15x70x55 mm	1	5604612723729
ASCS3C3PR	●			5604612723736



### END CAP FOR 3-CIRCUIT SURFACE MOUNTED TRACK

REF.	COLOUR	AxBxC	Box	EAN.
ASTFCS3CBR	○	31x33x31 mm	1	5604612723705
ASTFCS3CPR	●			5604612723712

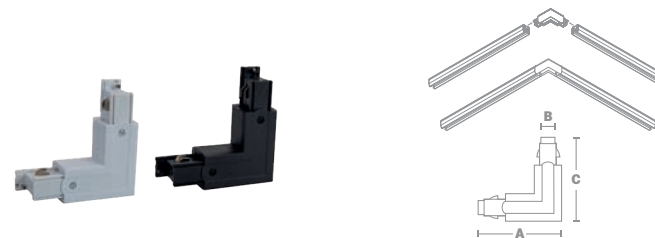

### L-TYPE CONNECTOR FOR 3-CIRCUIT SURFACE MOUNTED TRACK

REF.	COLOUR	AxBxC	Box	EAN.
ASUACS3CBR	○	98,5x25,5x98,5 mm	1	5604612723668
ASUACS3CPR	●			5604612723675

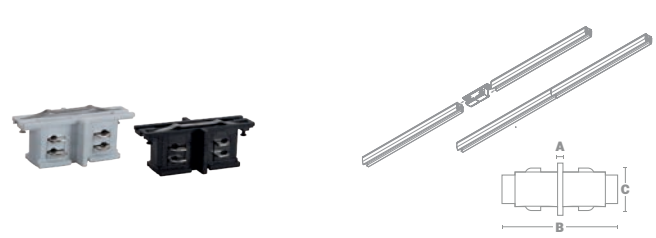

### CONNECTOR FOR 3-CIRCUIT SURFACE MOUNTED TRACK

REF.	COLOUR	AxBxC	Box	EAN.
ASUCS3CBR	○	3x69,5x25,5 mm	1	5604612723644
ASUCS3CPR	●			5604612723651

## > RECESSED

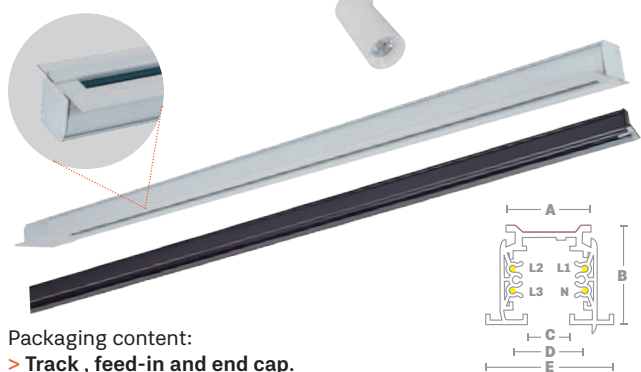

Packaging content:  
> Track , feed-in and end cap.

### 3-CIRCUIT RECESSED TRACK\*

REF.	COLOUR	AxBxCxD	m	EOB	EAN.
ASCE3C2BR	○	32,4x32,6x 14,5x22x55,7 mm	2	1	5604612723767
ASCE3C2PR <b>NEW</b>	●				5604612759094
ASCE3C3BR	○		3	1	5604612723774
ASCE3C3PR <b>NEW</b>	●				5604612759100

\* Track spot light not included.

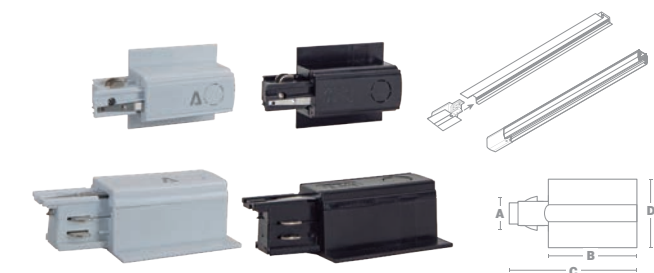

#### FEED-IN FOR 3-CIRCUIT RECESSED TRACK

REF.	COLOUR	AxBxCxD	EOB	EAN.
ASACE3CBR	○	25,5x66x98x56 mm	1	5604612723804
ASACE3CPR <b>NEW</b>	●			5604612759827

#### END CAP FOR 3-CIRCUIT RECESSED TRACK

REF.	COLOUR	AxBxC	EOB	EAN.
ASTFCE3CBR	○	31x33x31 mm	1	5604612723811
ASTFCE3CPR <b>NEW</b>	●			5604612759834

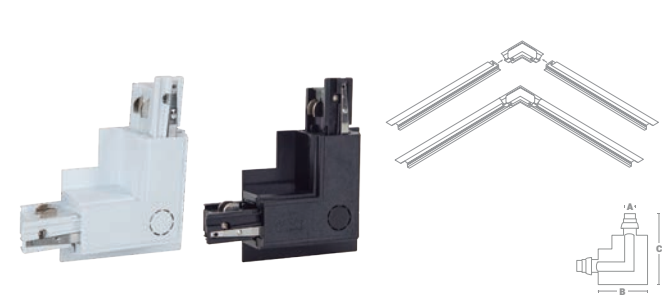
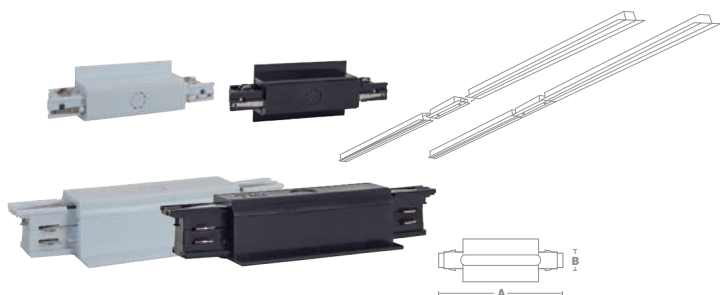

#### CONNECTOR FOR 3-CIRCUIT RECESSED TRACK

REF.	COLOUR	AxB	EOB	EAN.
ASUCE3CBR	○	16,5x25,5 mm	1	5604612723781
ASUCE3CPR <b>NEW</b>	●			5604612759803

#### L-TYPE CONNECTOR FOR 3-CIRCUIT RECESSED TRACK

REF.	COLOUR	AxBxC	EOB	EAN.
ASUACE3CBR	○	25,5x77,7x110,8 mm	1	5604612723798
ASUACE3CPR <b>NEW</b>	●			5604612759810

These accessories are a great complement to ASLO's new ranges of 3-circuit track spotlights: "LIVING" Series and "LOUNGE" Series.



## GLOBE Série SOLAR WALL LIGHT

### Illuminate with elegance and efficiency — discover the new 'GLOBE' solar wall light

Sophisticated, functional, and sustainable, the new solar wall light combines discreet and elegant design with cutting-edge outdoor lighting technology. With an opal globe that diffuses light smoothly and evenly, this wall light offers pleasant lighting of 1000 lumens over an area of up to 15m<sup>2</sup>, with a neutral colour temperature of 4000K — ideal for gardens, façades, or balconies.

Equipped with a high-efficiency monocrystalline solar panel and a 3.7V 2000mAh lithium-ion battery, it guarantees autonomy and excellent performance.

It has an On/Off switch and an operating mode selector, allowing you to switch between motion sensor and continuous lighting, adapting to your needs and the environment.



#### Floodlight:

- > Efficiency: 190Lm/W
- > LED: SMD 2835 (20Pcs)
- > CCT: 4000K
- > IP rating: IP54
- > IK rating: IK04
- > Housing: ABS
- > Diffuser: polycarbonate (PC)
- > Operating temperature: -20° to +60°C
- > Lighting area: 15m<sup>2</sup>

#### Sensor:

- > Detection distance: 5m
- > Mounting height: 2,5m
- > Detection range: 120°

#### Panel:

- > Monocrystalline 1,5W/4,86V DC

#### Battery:

- > Lithium-ion battery - 18650: 3,7V - 2000mAh
- > Solar charging time: 7h
- > Autonomy:
  - M1: 25% (ALS) - 38h
  - M2: 10% + PIR (30s) - 43h58m (if the sensor is not activated)
  - M4: 100% (ALS) - 48h
- > Switch cycles: 500

#### Operating modes:

- > M1: 25% till dawn
- > M2: 10% + PIR (30 sec)
- > M3: 0% + PIR (30 sec)
- > M4: 100% till dawn

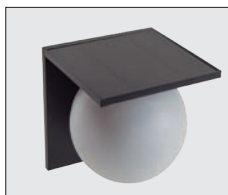

Solar panel



Sensor and ON/OFF button

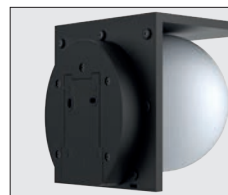

Easy to install

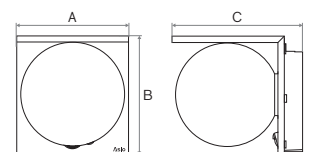

REF.	Color	Power	Lumens	CRI	A	B	C			EAN
ASGLOBE100040	●	5,3W	1000	>70	130mm	137mm	151mm	1	18	5604612759506

## RULE Series SOLAR WALL LIGHT

### Minimalist design, efficient performance — meet the new 'RULE' solar wall light

With its straight lines, discreet finish and soft indirect light, the new rectangular solar wall light is the ideal choice for those looking for elegance and functionality in outdoor environments. Its minimalist design integrates easily with different architectural styles, offering a modern and efficient lighting solution.

Equipped with a monocrystalline solar panel and a 3.7V 2000mAh lithium-ion battery, the wall light guarantees autonomy and reliable performance, illuminating up to 15m<sup>2</sup>, perfect for balconies, corridors, entrances, and exterior walls.

It has a motion sensor with a range of up to five metres, as well as an On/Off switch and an operating mode selector (sensor or continuous light), giving you greater control and saving battery power.

Style, practicality, and sustainability in a single product.



#### Floodlight:

- > Efficiency: 190Lm/W
- > LED: SMD 2835 (20Pcs)
- > Beam angle: 120°
- > CCT: 4000K
- > IP rating: IP44
- > IK rating: IK04
- > Housing: ABS
- > Diffuser: polycarbonate (PC)
- > UV protection
- > Operating temperature: -20° to +60°C
- > Lighting area: 15m<sup>2</sup>

#### Sensor:

- > Detection distance: max. 5m
- > Mounting height: 3m
- > Detection range: 120°
- > ON/OFF: Keep pressed for 1.5s
- > Choose modes: press briefly

#### Panel:

- > Monocrystalline 1,5W/4,86V DC
- > Dimensions: 283,5x53,5mm

#### Battery:

- > Lithium-ion battery - 18650: 3,7V - 2000mAh
- > Solar charging time: 7h
- > Autonomy:
  - M1: 25% (ALS) - 95h35m
  - M2: 10% + PIR (30s) - 17h27m (based on PIR was not be activated)
  - M4: 100% (ALS) - 28h21m
- > Switch cycles: 500

#### Operating modes:

- > M1: 25% till dawn
- > M2: 10% + PIR (30 sec)
- > M3: 0% + PIR (30 sec)
- > M4: 100% till dawn



Solar panel



Sensor and ON/OFF button



Easy to install

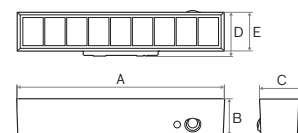

REF.	Color	Power	Lumens	CRI	A	B	C			EAN
ASRULE100040	●	5,3W	1000	>70	283,5mm	50mm	62,3mm	1	36	5604612759490

# Aslo

BRIGHTER LIFE

## TRIANGLE Série SOLAR WALL LIGHT

### Compact Wall Light with Indirect Light – TRIANGLE

Discreet, modern, and efficient, the new small-sized solar wall light is the ideal choice for those looking for functional lighting with a minimalist design. With indirect and diffused light, it offers a visually pleasing ambience, perfect for balconies, corridors, and small outdoor spaces.

The monocrystalline solar panel ensures efficient recharging of the 3.7V 2000mAh lithium-ion battery, enabling autonomous and sustainable operation. Equipped with a motion sensor with a range of up to five metres, the wall light easily adapts to the user's needs via a button that lets you choose between continuous lighting or sensor activation.



#### Floodlight:

- > Efficiency: 190Lm/W
- > LED: SMD 2835 (36Pcs)
- > Beam angle: 120°
- > CCT: 4000K
- > IP rating: IP44
- > IK rating: IK04
- > Housing: ABS
- > Diffuser: polycarbonate (PC)
- > UV protection
- > Operating temperature: -10° a +55°C
- > Lighting area: 9m<sup>2</sup>

#### Sensor:

- > Detection distance: 5m
- > Mounting height: 2,5m
- > Detection range: 120°

#### Panel:

- > Monocrystalline 1,3W/4,86V DC

#### Battery:

- > Lithium-ion battery - 18650: 3,7V - 2000mAh
- > Solar charging time: ≥7,5h
- > Autonomy:
  - M1: 25% (ALS) - 59h
  - M2: 50% - 40h7m
  - M3: 75% (ALS) - 30h40m
  - M4: 100% (ALS) - 40h
- > Switch cycles: 500

#### Operating modes:

- > M1: 25% till dawn
- > M2: 50% till dawn
- > M3: 75% till dawn
- > M4: 100% till dawn



Solar panel



Sensor and ON/OFF button



Easy to install

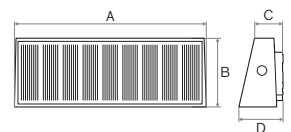

REF.	Color	Power	Lumens	CRI	A	B	C	D			EAN
ASTRI70040	●	3,7W	700	>70	178,1mm	64,1mm	26mm	35mm	1	80	5604612759513



## ACRYLIC FIXTURE

Indoor lighting

The empty acrylic fixture is a practical and reliable solution for interior lighting with T8 tubes. Its thermo-lacquered steel structure and polystyrene (PS) diffuser ensure resistance and even light distribution. The electrical connection is made only on one end, making it easy to install on ceilings or flat surfaces. With IP20 protection and insulation class I, it is suitable for use in dry indoor environments such as garages, workshops, or storerooms.

### Main features:

- > Compatible with T8 LED tubes with G13 cap;
- > Polystyrene (PS) diffuser and thermo-lacquered steel base;
- > Single-end connection for a simplified installation;
- > Insulation class I and IP20 rating;
- > Ideal for dry and protected interiors.

### Empty acrylic fixture

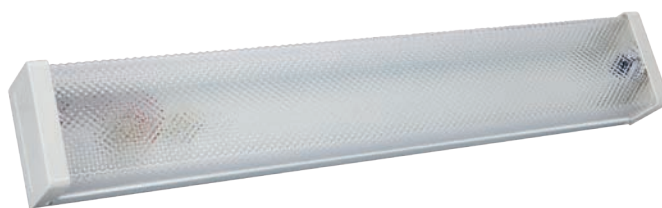

T8 | G13

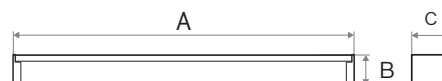

### Technical data:

- > Input voltage: 230V AC
- > Single-end connection
- > IP rating: IP20
- > Base: thermo-lacquered steel
- > Diffuser: polystyrene (PS)
- > Insulation class: I



REF.	Colour		A	B	C			EAN
ASAA160	○	1xG13	630mm	55mm	60mm	1	15	5604612754808
ASAA1120	○	1xG13	1240mm	55mm	60mm	1	15	5604612754839
ASAA260	○	2xG13	600mm	55mm	130mm	1	10	5604612754815
ASAA2120	○	2xG13	1245mm	55mm	130mm	1	10	5604612754822

# Aslo Electric

POWER ON



**CHARGERS AND  
ACCESSORIES**

ELECTRIC MOBILITY

aslo.pt

## Portable EV charger

- Maximum rated power: 3680W
  - IP rating: IP65
  - IK rating: IK10



Connector: Type 2



Selectable rated current: From 6A to 16A

### Main Features:

- > Charging per hour: 6A (1,38kWh)  
8A (1,84kWh)  
10A (2,30kWh)  
13A (2,99kWh)  
16A (3,68kWh)

- > Input voltage: 230V AC
- > Output voltage: 230V AC
- > Cable length: 5m

- > Cable insulation resistance: >1000 MΩ (DC 500V)
- > Input cable dimensions: 3x2,5mm<sup>2</sup> + 2x0,5mm<sup>2</sup>
- > Output cable dimensions: 3x2,5mm<sup>2</sup> + 1x0,5mm<sup>2</sup>
- > Display: Coloured
- > Electrical system: TN-C, TN-S, not suitable for TN-C-S system
- > Relative humidity (maximum value at 40°C): 75%
- > Operating temperature: -25°C -+45°C
- > Material: Polycarbonate
- > Certification: TUV CE, CB, RoHs



## Portable EV charger

3,68kW



Storage bag

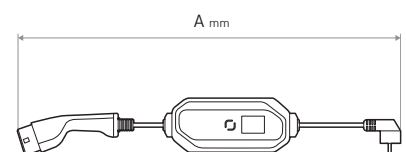

REF.	Colour	Dimensions (A)			EAN
ASVECP	●	5000mm	1	4	5604612752118

## Charging station

- Compact and attractive design
- Display: Coloured
- Residual current device: 6mA DC /30mA AC
- Residential applications
- Quick and easy installation
- IP rating: IP65



Integrated 5m cable with Type 2 connector



Installation: on pedestal or wall



RFID reader for card access



Accessories included



### Single-phase charging station

7,4kW



#### Main Features:

- > Supply voltage: 230V AC
- > Rated current: 32A
- > Frequency: 50Hz
- > Dynamic load balancing\*
- > External MID measurement\*
- > Integrated 6mA DC differential protection\*\*
- > OCPP Protocol
- > Charger management app
- > Material: Polycarbonate

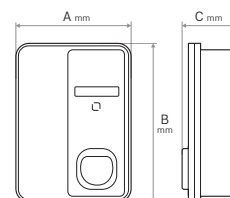

REF.	Colour	A	B	C			EAN
ASVEPC7	○	245mm	335mm	130mm	1	1	5604612752125



### Three-phase charging station

22kW



#### Main Features:

- > Supply voltage: 400V AC
- > Rated current: 32A
- > Frequency: 50Hz
- > Dynamic load balancing\*
- > External MID measurement\*
- > Integrated 6mA DC differential protection\*\*
- > OCPP Protocol
- > Charger management app
- > Material: Polycarbonate

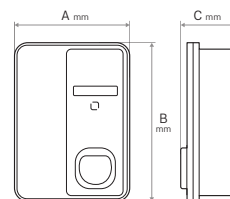

REF.	Colour	A	B	C			EAN
ASVEPC22	○	245mm	335mm	130mm	1	1	5604612752132

\*Through accessories.

\*\*Our charging station contains a device for detecting the continuous components of the fault current. With this range there is no need to protect the electric charging station with type B differentials.



## EV charging cable 22kW

### Main Features:

- > Supply voltage: 400V AC
- > Rated current: 32A
- > Frequency: 50 - 60Hz
- > Connector: Type 2
- > IP rating: IP65

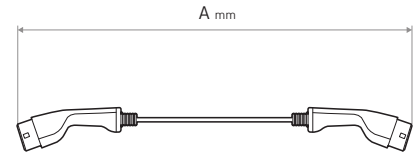

REF.	Colour	Dimensions (A)			EAN
ASVECC22	○	5000mm	1	4	5604612752149

## Accessories for Portable chargers / Charging stations for electric vehicles



Reference	ASVESCP	ASVESC	ASVEPPC
Designation	Electric vehicle portable charger holder	Electric vehicle charger storage bag	Electric vehicle charging station pedestal
This accessory can be used with the following references	ASVECP	ASVECP ASVECC22	ASVEPC7 ASVEPC22
Dimensions	105 x 65 x 290 mm	360 x 110 x 340 mm	150 x 1350 x 50 mm
EAN	5604612752156	5604612752163	5604612758684



Reference	ASVEC21	ASVECT2	ASVECT2GBT
Designation	Electric vehicle adapter type 2 to type 1	Electric vehicle adapter TESLA to type 2	Electric vehicle adapter type 2 to type GBT
Dimensions	200 x 90 x 90 mm	240 x 90 x 90 mm	200 x 90 x 90 mm
EAN	5604612752170	5604612752187	5604612752194

# Aslo

BRIGHTER LIFE



## Portable floodlight

### Technical data:

- > LED: SMD 2835
- > Input voltage: 100 - 240V AC
- > Frequency: 50-60Hz
- > Beam angle: 120°
- > Service life: 25.000h
- > Switch cycles: 15.000
- > IP rating: IP65
- > Housing: aluminium / polycarbonate (PC)
- > Diffuser: tempered glass
- > Insulation class: I
- > Standards: CE, RoHS
- > Cable: H05RN-F 3G1mm<sup>2</sup> - 1,5m



ON/OFF switch



Rotation: 360°



Inclination: 0°-90°

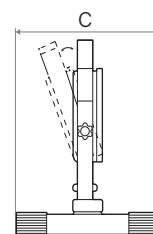
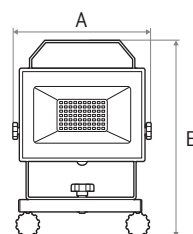

REF.	Colour	Power	Lumens	CCT	CRI	Energ. C.	A	B	C			EAN
ASPPB20		20W	1800Lm <sup>120°</sup>	6500K	80		144mm	200mm	162mm	1	8	5604612708511
ASPPB30		30W	2700Lm <sup>120°</sup>	6500K	80		215mm	242mm	183mm	1	8	5604612708528
ASPPB50 <b>NEW</b>		50W	5000Lm <sup>120°</sup>	6500K	80		145mm	290mm	250mm	1	8	5604612755492

# Aslo

**BRIGHTER LIFE**



**LIGHT BULBS**



## Standard LED bulb

A60 | E27 | 20.000h

### Technical data:

- > LED: SMD 2835
- > Beam angle: 220°
- > Input voltage: 220-240 V AC
- > Frequency: 50-60Hz
- > Switch cycles: 15.000
- > Service life: 20.000h
- > Housing: PVC
- > Cap: aluminium
- > Standards: CE, RoHS

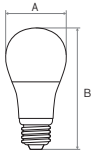

REF.		Power	Lumens	CCT	CRI	Energ. C.	A	B			EAN
ASLA608530		8,5W	806Lm <sup>360°</sup>	3000K	80		60mm	108mm	10	100	5604612751784
ASC10LA608530 - Pack 10	<b>NEW</b>	8,5W	806Lm <sup>360°</sup>	3000K	80		60mm	108mm	1	10	5604612742010
ASLA608540		8,5W	806Lm <sup>360°</sup>	4000K	80		60mm	108mm	10	100	5604612726386
ASC3LA608540 - Pack 3		8,5W	806Lm <sup>360°</sup>	4000K	80		60mm	108mm	1	40	5604612726492
ASC10LA608540 - Pack 10	<b>NEW</b>	8,5W	806Lm <sup>360°</sup>	4000K	80		60mm	108mm	1	10	5604612742027
ASLA608565		8,5W	806Lm <sup>360°</sup>	6500K	80		60mm	108mm	10	100	5604612726379
ASC3LA608565 - Pack 3		8,5W	806Lm <sup>360°</sup>	6500K	80		60mm	108mm	1	40	5604612726485
ASC10LA608565 - Pack 10	<b>NEW</b>	8,5W	806Lm <sup>360°</sup>	6500K	80		60mm	108mm	1	10	5604612752811



## Standard LED bulb

A60 | E27 | 20.000h

### Technical data:

- > LED: SMD 2835
- > Beam angle: 180°
- > Input voltage: 220-240 V AC
- > Frequency: 50-60Hz
- > Switch cycles: 15.000
- > Service life: 20.000h
- > Housing: PC - Polycarbonate
- > Cap: aluminium
- > Standards: CE, RoHS

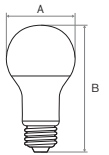

REF.		Power	Lumens	CCT	CRI	Energ. C.	A	B			EAN
ASLA6010530	<b>NEW</b>	10,5W	1055Lm <sup>360°</sup>	3000K	80		60mm	114mm	1	10	5604612751807
ASC10LA6010530 - Pack 10	<b>NEW</b>	10,5W	1055Lm <sup>360°</sup>	3000K	80		60mm	114mm	1	10	5604612742041
ASLA6010540	<b>NEW</b>	10,5W	1055Lm <sup>360°</sup>	4000K	80		60mm	114mm	1	10	5604612751791
ASC10LA6010540 - Pack 10	<b>NEW</b>	10,5W	1055Lm <sup>360°</sup>	4000K	80		60mm	114mm	1	10	5604612742034
ASLA6010565	<b>NEW</b>	10,5W	1055Lm <sup>360°</sup>	6500K	80		60mm	114mm	1	10	5604612752880
ASC10LA6010565 - Pack 10	<b>NEW</b>	10,5W	1055Lm <sup>360°</sup>	6500K	80		60mm	114mm	1	10	5604612752804



## Standard LED bulb

A60 | E27 | 20.000h

### Technical data:

- > LED: SMD 2835
- > Beam angle: 180°
- > Input voltage: 220-240 V AC
- > Frequency: 50-60Hz
- > Switch cycles: 15.000
- > Service life: 20.000h
- > Housing: PC - Polycarbonate
- > Cap: aluminium
- > Standards: CE, RoHS

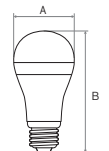

REF.		Power	Lumens	CCT	CRI	Energ. C.	A	B			EAN
ASLA601530	<b>NEW</b>	15W	1521Lm <sup>360°</sup>	3000K	80		60mm	125mm	1	10	5604612751814
ASC10LA601530 - Pack 10	<b>NEW</b>	15W	1521Lm <sup>360°</sup>	3000K	80		60mm	125mm	1	10	5604612742058
ASLA601540	<b>NEW</b>	15W	1521Lm <sup>360°</sup>	4000K	80		60mm	125mm	1	10	5604612751821
ASC10LA601540 - Pack 10	<b>NEW</b>	15W	1521Lm <sup>360°</sup>	4000K	80		60mm	125mm	1	10	5604612742065
ASLA601565	<b>NEW</b>	15W	1521Lm <sup>360°</sup>	6500K	80		60mm	125mm	1	10	5604612752873
ASC10LA601565 - Pack 10	<b>NEW</b>	15W	1521Lm <sup>360°</sup>	6500K	80		60mm	125mm	1	10	5604612752828



## Standard LED bulb

A65 | E27 | 20.000h

### Technical data:

- > LED: SMD 2835
- > Beam angle: 180°
- > Input voltage: 220-240 V AC
- > Frequency: 50-60Hz
- > Switch cycles: 15.000
- > Service life: 20.000h
- > Housing: PC - Polycarbonate
- > Cap: aluminium
- > Standards: CE, RoHS

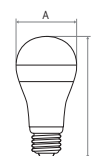

REF.		Power	Lumens	CCT	CRI	Energ. C.	A	B			EAN
ASLA651730	<b>NEW</b>	17W	1770Lm <sup>360°</sup>	3000K	80		65mm	134mm	1	10	5604612751838
ASC10LA651730 - Pack 10	<b>NEW</b>	17W	1770Lm <sup>360°</sup>	3000K	80		65mm	134mm	1	10	5604612742089
ASLA651740	<b>NEW</b>	17W	1770Lm <sup>360°</sup>	4000K	80		65mm	134mm	1	10	5604612751845
ASC10LA651740 - Pack 10	<b>NEW</b>	17W	1770Lm <sup>360°</sup>	4000K	80		65mm	134mm	1	10	5604612742072
ASLA651765	<b>NEW</b>	17W	1770Lm <sup>360°</sup>	6500K	80		65mm	134mm	1	10	5604612752903
ASC10LA651765 - Pack 10	<b>NEW</b>	17W	1770Lm <sup>360°</sup>	6500K	80		65mm	134mm	1	10	5604612752835

## Spherical led bulb

G45 | E27 | 20.000h



### Technical data:

- > LED: SMD 2835
- > Beam angle: 180°
- > Input voltage: 220-240 V AC
- > Frequency: 50-60Hz
- > Switch cycles: 15.000
- > Service life: 20.000h
- > Housing: PVC
- > Cap: aluminium
- > Standards: CE, RoHS

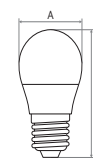

REF.		Power	Lumens	CCT	CRI	Energ. C.	A	B			EAN
ASLL454530	<b>NEW</b>	4,5W	470Lm <sup>360°</sup>	3000K	80		45mm	80mm	10	100	5604612751906
ASC10LL454530 - Pack 10	<b>NEW</b>	4,5W	470Lm <sup>360°</sup>	3000K	80		45mm	80mm	1	10	5604612742126
ASLL454540		4,5W	470Lm <sup>360°</sup>	4000K	80		45mm	80mm	10	100	5604612726447
ASC3LL454540 - Pack 3		4,5W	470Lm <sup>360°</sup>	4000K	80		45mm	80mm	1	40	5604612726546
ASC10LL454540 - Pack 10	<b>NEW</b>	4,5W	470Lm <sup>360°</sup>	4000K	80		45mm	80mm	1	10	5604612742119
ASLL454565		4,5W	470Lm <sup>360°</sup>	6500K	80		45mm	80mm	10	100	5604612726430
ASC3LL454565 - Pack 3		4,5W	470Lm <sup>360°</sup>	6500K	80		45mm	80mm	1	40	5604612726553
ASC10LL454565 - Pack 10	<b>NEW</b>	4,5W	470Lm <sup>360°</sup>	6500K	80		45mm	80mm	1	10	5604612752859

## Drop LED bulb

G45 | E14 | 20.000h



### Technical data:

- > LED: SMD 2835
- > Beam angle: 180°
- > Input voltage: 220-240 V AC
- > Frequency: 50-60Hz
- > Switch cycles: 15.000
- > Service life: 20.000h
- > Housing: PVC
- > Cap: aluminium
- > Standards: CE, RoHS

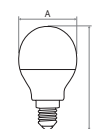

REF.		Power	Lumens	CCT	CRI	Energ. C.	A	B			EAN
ASLG454530	<b>NEW</b>	4,5W	470Lm <sup>360°</sup>	3000K	80		45mm	80mm	10	100	5604612751890
ASC10LG454530 - Pack 10	<b>NEW</b>	4,5W	470Lm <sup>360°</sup>	3000K	80		45mm	80mm	1	10	5604612742102
ASLG454540		4,5W	470Lm <sup>360°</sup>	4000K	80		45mm	80mm	10	100	5604612726409
ASC3LG454540 - Pack 3		4,5W	470Lm <sup>360°</sup>	4000K	80		45mm	80mm	1	40	5604612726508
ASC10LG454540 - Pack 10	<b>NEW</b>	4,5W	470Lm <sup>360°</sup>	4000K	80		45mm	80mm	1	10	5604612742096
ASLG454565		4,5W	470Lm <sup>360°</sup>	6500K	80		45mm	80mm	10	100	5604612726393
ASC3LG454565 - Pack 3		4,5W	470Lm <sup>360°</sup>	6500K	80		45mm	80mm	1	40	5604612726515
ASC10LG454565 - Pack 10	<b>NEW</b>	4,5W	470Lm <sup>360°</sup>	6500K	80		45mm	80mm	1	10	5604612752842



## LED candle bulb

C37 | E14 | 20.000h

**Technical data:**

- > LED: SMD 2835
- > Beam angle: 180°
- > Input voltage: 220-240 V AC
- > Frequency: 50-60Hz
- > Switch cycles: 15.000
- > Service life: 20.000h
- > Housing: PVC
- > Cap: aluminium
- > Standards: CE, RoHS

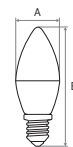

REF.		Power	Lumens	CCT	CRI	Energ. C.	A	B			EAN
ASLC374530	<b>NEW</b>	4,5W	470Lm <sup>360°</sup>	3000K	80		37mm	100mm	10	100	5604612751852
ASC10LC374530 - Pack 10	<b>NEW</b>	4,5W	470Lm <sup>360°</sup>	3000K	80		37mm	100mm	1	10	5604612742140
ASLC374540		4,5W	470Lm <sup>360°</sup>	4000K	80		37mm	100mm	10	100	5604612726423
ASC3LC374540 - Pack 3		4,5W	470Lm <sup>360°</sup>	4000K	80		37mm	100mm	1	40	5604612726522
ASC10LC374540 - Pack 10	<b>NEW</b>	4,5W	470Lm <sup>360°</sup>	4000K	80		37mm	100mm	1	10	5604612742133
ASLC374565		4,5W	470Lm <sup>360°</sup>	6500K	80		37mm	100mm	10	100	5604612726416
ASC3LC374565 - Pack 3		4,5W	470Lm <sup>360°</sup>	6500K	80		37mm	100mm	1	40	5604612726539
ASC10LC374565 - Pack 10	<b>NEW</b>	4,5W	470Lm <sup>360°</sup>	6500K	80		37mm	100mm	1	10	5604612752866



## LED bulb

GU10 | 20.000h

**Technical data:**

- > LED: SMD 2835
- > Beam angle: 38°
- > Input voltage: 220-240 V AC
- > Frequency: 50-60Hz
- > Switch cycles: 15.000
- > Service life: 20.000h
- > Housing: Glass
- > Cap: aluminium
- > Standards: CE, RoHS

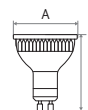

REF.		Power	Lumens	CCT	CRI	Energ. C.	A	B			EAN
ASLEDV104930		4,9W	445Lm <sup>360°</sup>	3000K	80		50mm	54mm	10	100	5604612726454
ASC10LV104930 - Pack 10	<b>NEW</b>	4,9W	445Lm <sup>360°</sup>	3000K	80		50mm	54mm	1	10	5604612751968
ASLEDV104940		4,9W	445Lm <sup>360°</sup>	4000K	80		50mm	54mm	10	100	5604612726461
ASC10LV104940 - Pack 10	<b>NEW</b>	4,9W	445Lm <sup>360°</sup>	4000K	80		50mm	54mm	1	10	5604612751975
ASLEDV104965		4,9W	445Lm <sup>360°</sup>	6500K	80		50mm	54mm	10	100	5604612726478
ASC10LV104965 - Pack 10	<b>NEW</b>	4,9W	445Lm <sup>360°</sup>	6500K	80		50mm	54mm	1	10	5604612752897

# Aslo Electric

POWER ON

**HEAT-SHRINKABLE TUBES**

aslo.pt

## HEAT-SHRINKABLE TUBE WITHOUT ADHESIVE

ASLO has an extensive range of heat-shrinkable tubes in different colours, ideal for organising and identifying cables and conductors.

### Material:

Radiation cross-linked polyolefin tube, characterised by its resistance, flexibility and excellent protection against solvents and fluids in general, and with a high dielectric strength.

### Application:

Ideal for protecting and insulating connectors, electrical busbars, and electrical harnesses.

### Features:

- > Flexible;
- > Flame retardant;
- > Continuous operating temperature: -55°C ~ 125°C;
- > Total shrinkage temperature: ≥125°C.

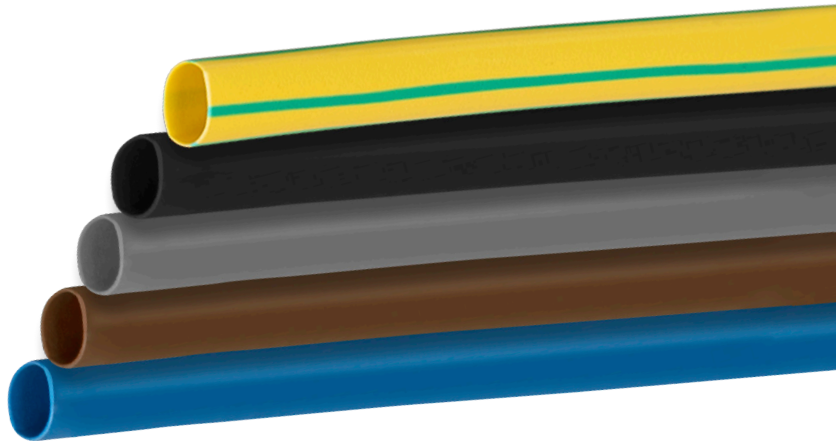

REF.	Colour	Ø (mm)	M/Box	EAN
ASCDTTPFSR2AZ	●	2,0/1,0	15M	5604612752422
ASCDTTPFSR2CT	●			5604612752590
ASCDTTPFSR2CZ	●			5604612752514
ASCDTTPFSR2PR	●			5604612752330
ASCDTTPFSR2VA	●			5604612752606
ASCDTTPFSR3AZ	●	3,0/1,5	15M	5604612752439
ASCDTTPFSR3CT	●			5604612752699
ASCDTTPFSR3CZ	●			5604612752521
ASCDTTPFSR3PR	●			5604612752347
ASCDTTPFSR3VA	●			5604612752613
ASCDTTPFSR4AZ	●	4,5/2,3	12M	5604612752446
ASCDTTPFSR4CT	●			5604612752705
ASCDTTPFSR4CZ	●			5604612752538
ASCDTTPFSR4PR	●			5604612752354
ASCDTTPFSR4VA	●			5604612752620
ASCDTTPFSR6AZ	●	6,0/3,0	12M	5604612752453
ASCDTTPFSR6CT	●			5604612752712
ASCDTTPFSR6CZ	●			5604612752545
ASCDTTPFSR6PR	●			5604612752361
ASCDTTPFSR6VA	●			5604612752637
ASCDTTPFSR8AZ	●	8,0/4,0	8M	5604612752460
ASCDTTPFSR8CT	●			5604612752729
ASCDTTPFSR8CZ	●			5604612752552
ASCDTTPFSR8PR	●			5604612752378
ASCDTTPFSR8VA	●			5604612752644

REF.	Colour	Ø (mm)	M/Box	EAN
ASCDTTPFSR13AZ	●	13,0/6,5	8M	5604612752477
ASCDTTPFSR13CT	●			5604612752736
ASCDTTPFSR13CZ	●			5604612752569
ASCDTTPFSR13PR	●			5604612752385
ASCDTTPFSR13VA	●			5604612752651
ASCDTTPFSR16AZ	●	16,0/8,0	8M	5604612752484
ASCDTTPFSR16CT	●			5604612752743
ASCDTTPFSR16CZ	●			5604612752798
ASCDTTPFSR16PR	●			5604612752415
ASCDTTPFSR16VA	●			5604612752668
ASCDTTPFSR18AZ	●	18,0/9,0	5M	5604612752491
ASCDTTPFSR18CT	●			5604612752750
ASCDTTPFSR18CZ	●			5604612752576
ASCDTTPFSR18PR	●			5604612752392
ASCDTTPFSR18VA	●			5604612752675
ASCDTTPFSR25AZ	●	25,0/12,5	5M	5604612752507
ASCDTTPFSR25CT	●			5604612752767
ASCDTTPFSR25CZ	●			5604612752583
ASCDTTPFSR25PR	●			5604612752408
ASCDTTPFSR25VA	●			5604612752682





## HEAT-SHRINKABLE TUBE KIT 53UN.

WITH ADHESIVE – 3:1 (BLACK)

3,2 mm - 16 un.  
 4,8 mm - 12 un.  
 6,4 mm - 9 un.  
 9,5 mm - 5 un.  
 12,7 mm - 8 un.  
 19,1 mm - 3 un.





REF.	Colour	DIM.			EAN
ASKTTPDR53PR	●	10CM	1	50	5604612752774

## HEAT-SHRINKABLE TUBE KIT 125UN.

WITHOUT ADHESIVE – 2:1 (5 COLOURS)

2,0 mm - 6 un./colour  
 3,0 mm - 6 un./colour  
 4,5 mm - 5 un./colour  
 6,0 mm - 3 un./colour  
 8,0 mm - 3 un./colour  
 13,0 mm - 2 un./colour



REF.	Colours	DIM.			EAN
ASKTTPFSR125C5	● ● ● ● ●	10CM	1	50	5604612752781

aslo.pt



# Aslo

BRIGHTER LIFE

## LED GLOBE BULB

LIGHT BULBS



### LED globe bulb

G150 | E27 | 15.000h

#### Technical data:

- > LED: SMD 2835
- > Beam angle: 220°
- > Switch cycles: 20.000
- > Input voltage: 170-265 V AC
- > Frequency: 50-60Hz

- > Service life: 15.000h
- > Housing: PVC
- > Cap: aluminium
- > Output current: 160mA
- > Displacement factor: 0,70
- > Standards: CE, RoHS

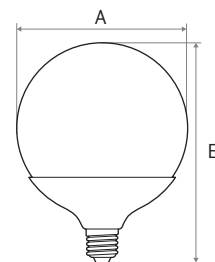

REF.	Power	Lumens	CCT	CRI	A	B			EAN
ASLEDG272340	23W	2400Lm <sup>360°</sup>	4000K	80	150mm	190mm	1	24	5604612754464

## Series SOLLUZ SOLAR LED FLOODLIGHT WITH REMOTE CONTROL

The new LED Floodlights with Remote Control feature a monocrystalline silicon panel, which emphasises their discreet and elegant design. The solar LED property makes these floodlights an excellent choice for outdoor environments. They also feature a colour temperature selector, allowing you to choose between 4000K and 6000K. The remote control promotes and enables a more convenient use. The floodlights are equipped with an ON/OFF button and different operating modes, offering a choice between the automatic sensor mode and continuous lighting mode.



### Floodlight:

- > Efficiency: 160Lm/W
- > LED: SMD 2835 (252Pcs)
- > Beam angle: 60°x120°
- > 2CCT: 4000K and 6000K
- > IP rating: IP65
- > IK rating: IK08
- > Housing: ABS and polycarbonate (PC)
- > UV protection
- > Fire resistant VO
- > Operating temperature: -20° to +50° C

### Sensor:

- > Mounting height: 2-6m
- > Detection distance: 16-18m
- > Detection range: 120°
- > Lighting area: 180m<sup>2</sup>

### Panel:

- > Monocrystalline 22W/20V DC
- > Dimensions: 354,6x518,7x35mm
- > Connection cable (with IP67 connector): 5m

### Battery:

- > LiFePO4 battery - 32700: 12,8V - 6000mAh
- > Solar charging time: 5-6h
- > Autonomy (fully charged): up to 60h
- > Switch cycles: 2000
- > Replaceable battery

### Operating modes:

- > M1: Automatic sensor mode
- > M2: Continuous lighting mode



Contains remote control



Monocrystalline silicon panel



Contains motion sensor



Modes and ON/OFF button

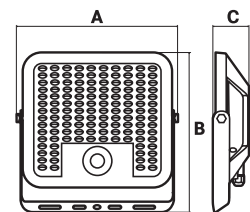

REF.	Color	Power	Lumens	CRI	A	B	C			EAN
ASSOL60C2	●	60W	9600	80	263,2mm	245mm	54,8mm	1	4	5604612754501

# Aslo

BRIGHTER LIFE

## LED STRIP REELS

7W - 12W

[aslo.pt](http://aslo.pt)



# LED STRIP REELS

## 7W - 12W

> ASLO's LED Strip Reels represent a practical and versatile lighting solution. This product can be used as a light source in a variety of domestic, professional, or industrial contexts.

**Technical data:**

- > Supply voltage: 230 V AC
- > Frequency: 50-60Hz
- > Beam angle: 120°
- > CCT: 4000K
- > Service life: 30.000h
- > Switch cycles: 15.000
- > IP rating: IP65
- > Strip material: PVC
- > Operating temperature: -10° to +40°C
- > Insulation class: II
- > Cable: H05RN-F 3G0,75mm<sup>2</sup> - 3m



### LED strip reel - 7W 230V | IP65



**Technical data:**

- > LED: 120 SMD 2835/m
- > Useful lumens: 590Lm/m<sup>360</sup>
- > Cut: 1000mm

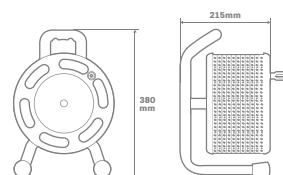
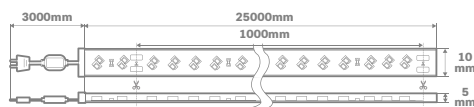

REF.	Roll	PCB	Watts	CRI			EAN
ASFLE23074025	25 metros	10mm	7W/m	80	1	1	5604612752040



### LED strip reel - 12W 230V | IP65



**Technical data:**

- > LED: 180 SMD 2835/m
- > Useful lumens: 1280Lm/m<sup>360</sup>
- > Cut: 1000mm

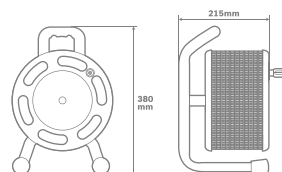
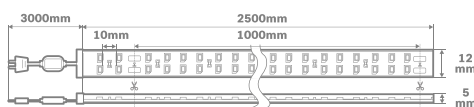

REF.	Roll	PCB	Watts	CRI			EAN
ASFLE230124025	25 metros	12mm	12W/m	80	1	1	5604612752057



## DOUBLE SOCKETS USB A + C



### Main features:

- > Vertical or horizontal fitting system (multiple posts);
- > Double claws protected in the neutral position for greater safety;

- > Rated voltage: 110-240V AC 50-60Hz;
- > Max.: 0,5A.

### USB outlets:

- > 5~12V;
- > Max.: 20W.



### Double socket USB A + C

EUROPA 2020 Series

REF.	Colour			EAN
ASE202019BRC	○ White	10	120	5604612752255
ASE202019MFC	● Ivory	10	120	5604612752262
ASE202019ALC	● Aluminium	10	120	5604612752279



### Cover plate for double socket USB A + C

EUROPA 2020 Series

REF.	Colour			EAN
ASE202019BR	○ White	30	360	5604612752217
ASE202019MF	● Ivory	30	360	5604612752224
ASE202019AL	● Aluminium	30	360	5604612752231



### Double socket USB A + C

MECAN 2020 Series

REF.			EAN
ASM202019	10	120	5604612752248



# Aslo

**BRIGHTER LIFE**

**TEU Series**

**FLOODLIGHTS AND SENSOR**

Outdoor Lighting

[aslo.pt](http://aslo.pt)

# TEU Series FLOODLIGHTS

The TEU series floodlight is a multi-design professional range floodlight with integrated 3-CCT technology, giving the user the possibility to choose the colour temperature (3000K, 4000K and 6000K), 3 selectable powers and an interface for connecting an optional PIR motion sensor. With a structure made from high-strength die-cast aluminium that guarantees efficient heat dissipation.

The TEU projector has an 'anti-glare' tempered glass diffuser and a vent valve to prevent condensation in the optical system. Its elegant lines make this floodlight an asset to any project. The versatility of the TEU floodlight reduces the need for extra stocks and investment in additional references, increasing the market offer.



## Power adjustable floodlight with sensor interface



### Technical data:

- > LED: SMD 2835
- > 3CCT: 3000K, 4000K and 6000K
- > Input voltage: 220-240 V AC
- > Frequency: 50-60Hz
- > Service life: 35,000h
- > Switch cycles: 50,000
- > Beam angle: 120°
- > IK rating: IK08
- > IP rating: IP66
- > Housing: aluminium
- > Diffuser: tempered glass
- > Operating temperature: -20° to 45°C
- > Insulation class: I
- > DOB technology (Driver On Board)
- > Cable: H05RN-F 3G1.0mm<sup>2</sup> - 0.50m

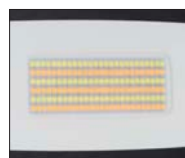

Anti-glare glass



'Easyfit' sensor connection system



Vent valve

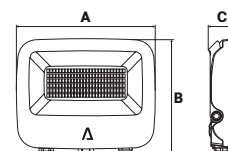

REF.	Colour	Power	Total Lumens	Useful Lumens	CRI	A	B	C			EAN
ASTEU50C3P	●	20-30-50W	5400	4700Lm <sup>120°</sup>	70	165mm	137mm	32mm	1	20	5604612748586
ASTEU100C3P	●	60-80-100W	10800	9400Lm <sup>120°</sup>	70	225mm	185mm	36mm	1	12	5604612748593
ASTEU200C3P	●	120-150-200W	21600	18800Lm <sup>120°</sup>	70	322mm	247mm	41mm	1	6	5604612748609



## Pluggable PIR sensor with remote control (3 modes)



### Technical data:

- > Voltage and current: 5 V DC, 10mA
- > Detection distance: 2 - 8M
- > Detection angle: 120°
- > Sensitivity: 25%/50%/75%/100%
- > Delay time: minimum 10 seconds and maximum 15 minutes
- > Luminous flux: 20/50/100Lux
- > IP rating: IP65
- > Mounting height: 1.8 - 4M
- > Remote control range: 0 - 8M
- > Operating temperature: -20° to 40°C
- > Double insulated

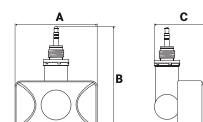

REF.	Power	A	B	C			EAN
ASTEUSP	20-200W	60mm	74,7mm	48,4mm	1	100	5604612748616



## WALL BRACKETS FOR FLOODLIGHTS

### Main features:

- > Material: aluminium;
- > Allows simple and aesthetic installation of LED floodlights on walls or ceilings;

- > They are compatible with our LED floodlights;
- > Ideal for lighting advertising posters, billboards, façades, gardens, terraces, industrial buildings and many other applications.



All brackets include M8\*80mm threaded screw + M10 sleeve anchor



### LED floodlight corner wall bracket

REF.	Colour				EAN
ASSCP	●	1.000Kg	1	20	5604612748739

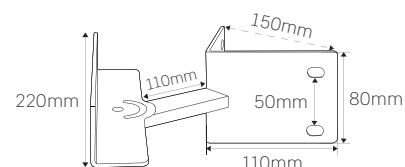

### LED floodlight wall bracket



REF.	Colour	A				EAN
ASSPP500	●	500mm	0.817 Kg	1	10	5604612748715
ASSPP1000	●	1000mm	1.236 Kg	1	6	5604612748722

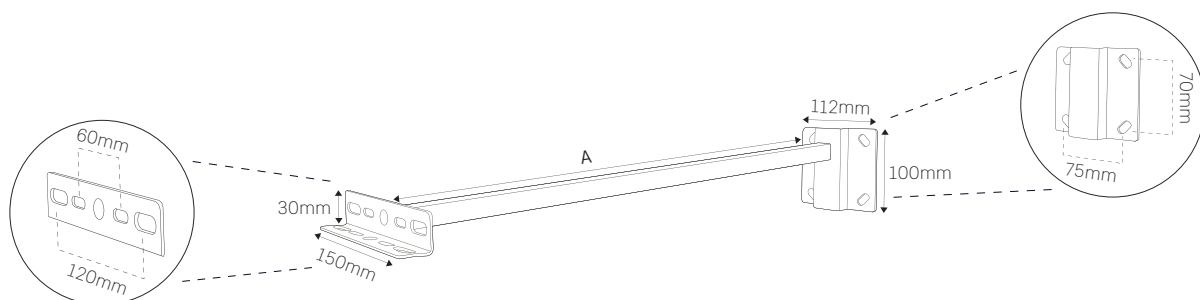

# Aslo Electric

## **POP-UP DESK SOCKETS**

**POWER ON**

**aslo.pt**

A photograph of a modern office interior. The scene is brightly lit, featuring several desks with computers and office chairs. The ceiling is white with a grid of recessed lighting. In the foreground, a desk is visible with a computer monitor and a chair. In the background, another desk is visible with a computer monitor and a chair. The floor is light-colored wood. The overall aesthetic is clean and professional.

## POP-UP Desk sockets

- Rated power: max 3680W
- Current intensity: 16A
- IP rating: IP20



ASLO's new POP-UP desk sockets, with and without induction, represent an innovative and practical solution for charging mobile devices. With a recessed installation, these sockets have an elegant and functional design, guaranteeing a minimalist and organised look. The version without induction (ASBTPUD) has USB ports - type A and type C for charging devices. In addition, the option with induction (ASBTPUDI) also allows wireless charging, eliminating wires on your work surface and offering more versatility. These POP-UP sockets offer flexibility and efficiency, thus facilitating access to sockets and ensuring space optimisation.



1xUSB A /  
1xUSB C



3x Schuko-type sockets:  
250V AC 16A



Wireless charging (induction  
model only)



Cable H05 VV-F  
3G1,5mm<sup>2</sup> - 1,5m



### POP-UP Desk sockets

2P + T | USB A+C

#### Features:

- > Rated voltage: 250V AC
- > Cable H05 VV-F, 3G1,5mm<sup>2</sup> - 1,5m
- > Insulation class: I
- > USB-A (max. 18W): 5V-3A | 9V-2A | 12V-1,5A
- > USB-C (max. 20W): 5V-3A | 9V-2,2A | 12V-1,67A
- > USB A + C (max. 15W): 5V-3A

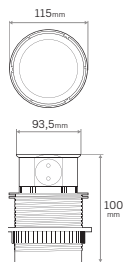

REF.	EAN		
ASBTPUD	5604612745660	1	8



### POP-UP Desk sockets + Induction

2P + T + 16A | USB A+C | **Wireless charging - QC 3.0**

#### Features:

- > Rated voltage: 250V AC
- > Cable: H05 VV-F, 3G1,5mm<sup>2</sup> - 1,5m
- > Insulation class: I
- > Wireless charger: max. 10W
- > Supports QC3.0 (Quick Charge 3.0)
- > USB A + C: 5,0V-3,0A máx. 15W | 9,0V-2,0A máx. 18W | 12V-1,5A máx. 18W

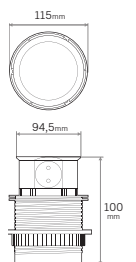

REF.	EAN		
ASBTPUDI	5604612745677	1	8



# Aslo Electric

## **DESK SOCKET WITH SLIDING COVER**

POWER ON

aslo.pt



### Desk socket with sliding cover

- Rated power: max 3680W
- Current intensity: 16A
- IP rating: IP20

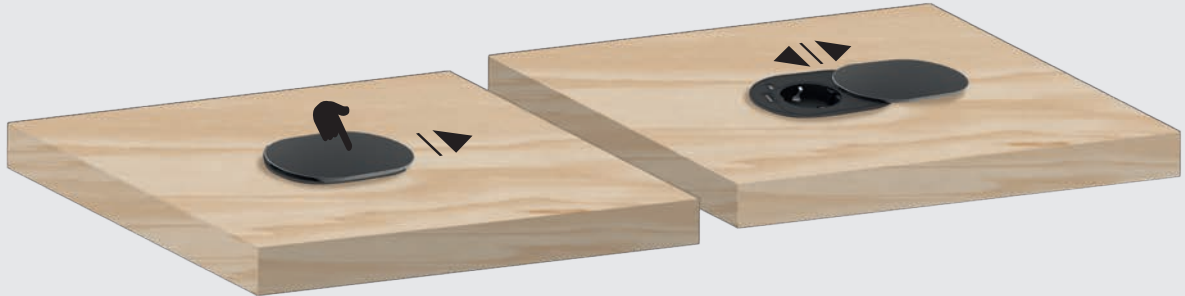

ASLO's desk socket with sliding cover (ASTED) is a sophisticated and efficient solution for charging devices in work environments. This product features a modern design as well as a discreet recessed installation. The sliding cover makes it possible to hide the socket and the USB ports – type A and type C when necessary, reinforcing its versatile and minimalist character. This desk socket allows you to charge safely and conveniently, ensuring the organisation of your workspaces.



1xUSB A /  
1xUSB C



Schuko-type socket:  
250V AC 16A

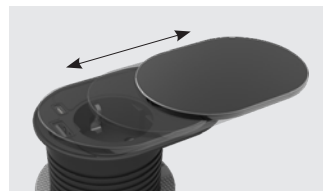

Sliding  
cover



Cable H05 VV-F  
3G1,5mm<sup>2</sup> - 1,5m

### Desk socket with sliding cover **NEW**

2P + T + 16A | USB A + C



**Features:**

- > Rated voltage: 250V AC
- > Cable H05 VV-F, 3G1,5mm<sup>2</sup> - 1,5m
- > Insulation class: I
- > USB-A (max. 18W): 5V-3A | 9V-2A | 12V-1,5A
- > USB-C (max. 20W): 5V-3A | 9V-2,2A | 12V-1,67A
- > USB A + C (max. 17W): 5V-3,4A

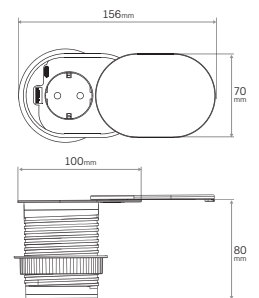

REF.	EAN		
ASTED	5604612745684	1	24