



LED SOLAR WAY

Lighting without energy costs
Increased safety and environmental sustainability





40w

- Solar LED street light "Way", with an elegant design, allows you to store solar energy during the day for night-time lighting. The system is totally autonomous, without requiring any connection to the electrical grid.
- Reduces energy bills while increasing environmental sustainability.
- It features an optical, anti-glare lens to optimise the efficiency of the light, making it much brighter.
- High performance lithium ion battery is a guarantee of greater capacity and operation time.
- High quality monocrystalline silicon solar panel, high conversion of solar energy and conversion rate.
- Integrated circuit device with overload, over discharge and overvoltage protection.

Installation on straight pole

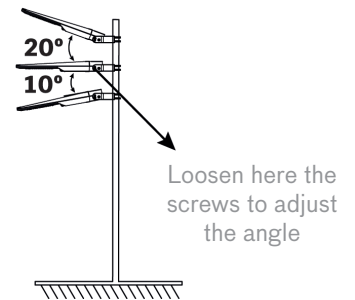

Installation on curved pole

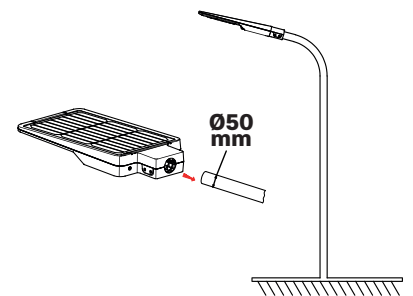

Product features:

- 2 operating modes: constant light, sensor mode.
- Solar-powered street light;
- Luminaire switches on automatically at dusk
 - a) High-sensitivity built-in sensor
 - b) Remote Control for DIY Mode (Timing and brightness function)
- It can be used as wall light, street light (street lighting);
- It can be installed in gardens, car parks, courtyards, streets, driveways, squares, pavements, among others;
- Replaceable high capacity and long life battery - Life PO4
- IP65-rated waterproof.

Wall-mounted

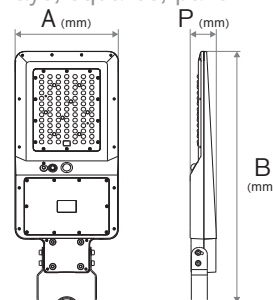
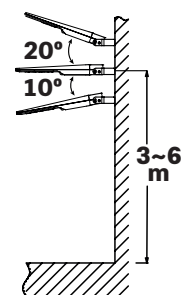

Accessories included



SOLAR LED STREET LIGHT WAY

REF ^a	W	LM	K	AxBxP	EAN code.	L.P
ASWAY4060	40	4800	6000	289,7mmx621,6x73,6mm	4	5604612722906 €

LED SOLAR LIGHT

40 W LED SMD 2835 90Pcs 140x70° 140° 70° IP 65 -20°-+60°C ABS + PC ALUM ANTI UV FIRE-PROOF V0

SENSOR

8~12m 3~6m 120°

BATTERY

9.6 V 12000mAh 32700 Li-ion LiFePO4 Battery 8-10h CYCLES 2000 X

SOLAR PANEL

21 W MONO CRYSTALLINE SILICON

REMOTE CONTROL

2H | 4H | 6H 8H | 10H | 12H TIMING FUNCTION <12 m



Aslo

BRIGHTER LIFE

ARENA SERIES



LED FLOODLIGHT

Outdoor lighting

aslo.pt



Nowadays, energy efficiency and visual comfort are important factors before choosing the right lighting. The new ASLO's high flux LED floodlight from ARENA Series is suitable for lighting large outdoor spaces such as sports pitch. In addition, it can also be used to light large parking areas, municipal parks or other large urban traffic areas. The floodlight ARENA ensures extraordinary light quality, with 5000K colour temperature and optimal colour rendering CRI80. It achieves a high flux of 140Lm/W, with reduced power consumption and offers the beam angles required for this type of lighting. It features a modular design that allows different combinations of opening of the beam angles with its double or triple modules, through the different lens options (25°, 45°, 60° and 90°) in order to get the ideal lighting for all needs. Equipped with LUMILEDS LEDs and MEAN WELL driver, the floodlight ARENA complies with the highest performance standards, providing extraordinary light quality and uniformity, with the assurance of safety and visual comfort.



Main features:

- > Modular for greater flexibility;
- > No flickering;
- > Instant re-lighting;
- > Comfort for sportsmen

ARENA LED FLOODLIGHT

Technical data:

Use:	Outdoor
Colour temperature:	5000K
LED type:	Lumileds SMD 3030
Beam angle:	90°
Driver:	MW - Mean Well ELG
Input voltage:	100-305V AC (50-60Hz)
Color rendering:	>80
Power factor:	>0,95
Surge protection:	10Kv
Guard protection:	IP66
Operating time:	50.000h
No. of ON/OFF switching cycles:	25.000
Methods of installation:	- Vertical - Horizontal - Suspended
Standards:	CE e RoHS
Temperature of operation:	-25°C+50°C

- > **480W**
- > 140Lm/W



- > **720W**
- > 140Lm/W

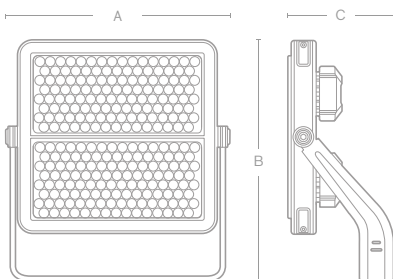

REF	W	K	Useful lumens	Total Lumens	A x B x C		EAN code
ASAR4809050	480	5000	45300 ^{90°}	67200	462x496x216mm	1	5604612723330
ASAR7209050	720		-	100800	462x676x216mm	1	5604612723347

> 3 METHODS OF INSTALLATION

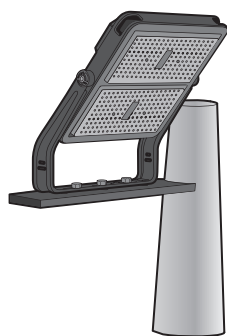

> Vertical installation

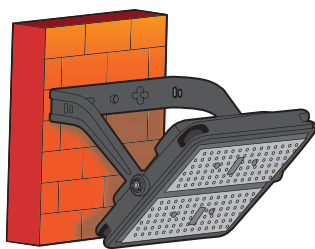

> Horizontal installation

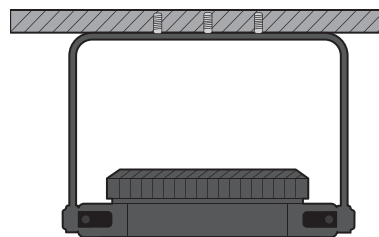

> Suspended installation

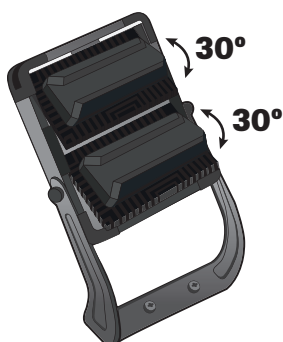

> Each module can be rotated up and down by 30°.

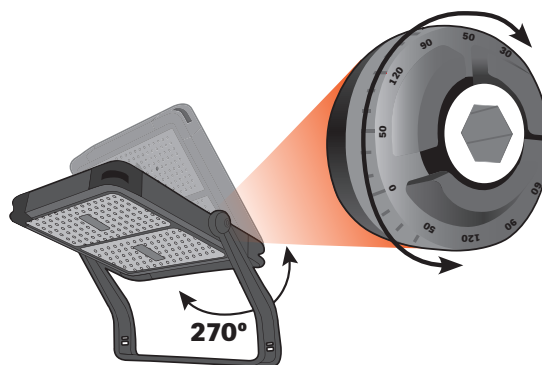

> Floodlight with 270° rotation. Possibility of setting the desired amplitude.

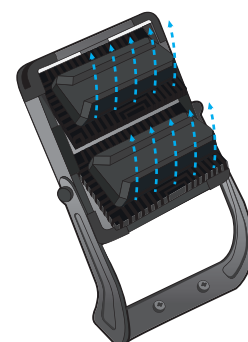



> Copper drain valve. Allows balancing the pressure and internal and external moisture.

ACCESSORIES FOR LED FLOODLIGHT

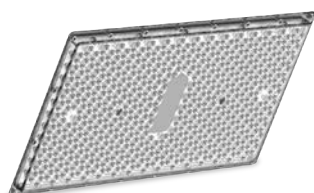

LENS FOR ARENA LED FLOODLIGHT





REF	BEAM ANGLE		EAN code
ASARL25	25°	1	5604612723354
ASARL45	45°	1	5604612723361
ASARL60	60°	1	5604612723378



MEAN WELL LED DRIVER

REF	W		EAN code
ASDLMWELG240	240	1	5604612723385



Technical data	ASAR4809050	ASAR7209050
Power:	480W	720W
Useful lumens:	45300lm ^{90°}	-
Total lumens:	67200lm	100800lm
Colour temperature:	5000K	5000K
LED chip:	LUMILEDS SMD 3030	LUMILEDS SMD 3030
No. of LED's:	686	1029
Input Voltage:	100-305V AC	100-305V AC
Beam angle:	90°*	90°*
Dimmable:	No	No
Lifespan:	50.000h	50.000h
No. of ON/OFF switching cycles:	25.000	25.000
Color rendering:	CRI>80	CRI>80
Power factor:	>0,9	>0,9
Guard protection:	IP66	IP66
Mechanical impact resistance rating:	IK08	IK08
Overvoltage protection:	10Kv	10Kv
Output current:	9A	13,5A
Insulation class:		
Energy class:		NA* ¹
Product dimensions:	462x496x216mm	462x676x216mm
Packaging dimension:	613x536x175mm	663x536x225mm
Weight with packaging:	16,80kg	22,80kg

*Possibility of changing the light beam of the floodlight, if a lens with different amplitudes is purchased separately, see references: ASARL25, ASARL45 and ASARL60.

*¹The ASAR7209050 720W floodlight does not have an EE label, as only lighting products between 60Lm and 82,000Lm are covered by the regulation.

Aslo

BRIGHTER LIFE

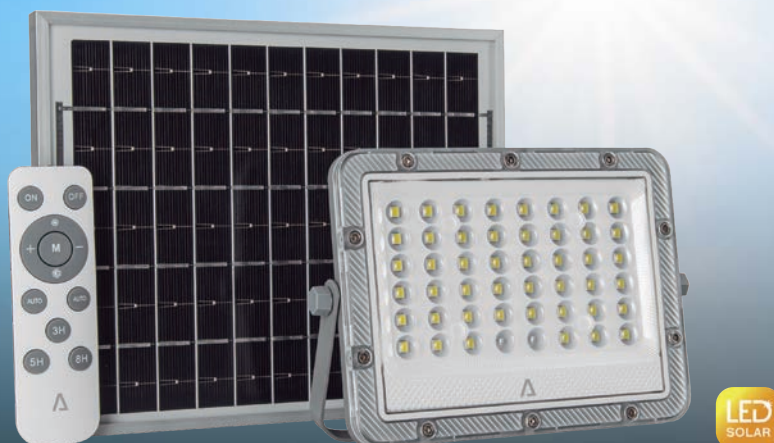

SOLAR LIGHT



aslo.pt

50
W



IP
65



REMARK:

Press the "AUTO" button to activate the LED solar floodlight when you use it for the first time.

The new ASLO's 50W floodlight with Solar Panel + Remote Control has a high capacity and durable battery and incorporates a brightness sensor and is ideal to illuminate, in an automated way and without the need for electric current, any outdoor area.

Main features:

- 2 operating modes
- Outdoor use
- Zero electricity costs
- IP65 (waterproof)
- Easy to install
- Solar powered luminaire
- Lights up automatically at dusk

Brightness modes:

- 100% first hour
- 80% second hour
- 60% third hour
- 50% fourth hour
- 30% fifth hour

Operating Modes:

- **Easy Operation:** You can use the LED floodlight connected to the solar panel or independently, in the latter case it does not work in automatic mode and is turned off or on from the remote control.
- **Automatic mode:** This mode is only possible with the solar panel permanently activated, so it only switches on the LED floodlight when it detects a brightness lower than 50lux, otherwise it shuts down. In this way, it automatically turns on at night and turns off automatically during the day.
- **Manual mode:** When you press the ON/OFF button, the LED floodlight turns on and when you press the same button again, the projector will turn off regardless of the brightness of the environment.

Remote control:

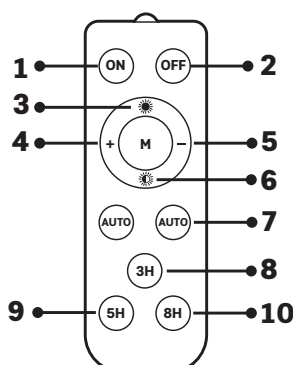

- 1 - Switch on
- 2 - Switch off
- 3 - Full brightness
- 4 - Increase brightness
- 5 - Reduce brightness
- 6 - Half brightness
- 7 - Auto (automatically switches on at night by light emission control)
- 8 - Turns on after dusk, switches off automatically after 3 hours
- 9 - Turns on after dusk, switches off automatically after 5 hours
- 10 - Turns on after dusk, switches off automatically after 8 hours

ON/OFF button: the LED floodlight switches on and when the same button is pressed again, the projector switches off. Regardless of the environment brightness

OFF button: activates/deactivates the light sensor mode.

3H button: turns on the LED floodlight for a continuous period of 3 hours and repeats the process on the following days

5H button: turns on the LED floodlight for a continuous period of 5 hours and repeats the process on the following days

8H button: turns on the LED floodlight for a continuous period of 8 hours and repeats the process on the following days

Maximum brightness button: Increases the brightness.

Minimum brightness button: Decreases the brightness.

Optional accessory

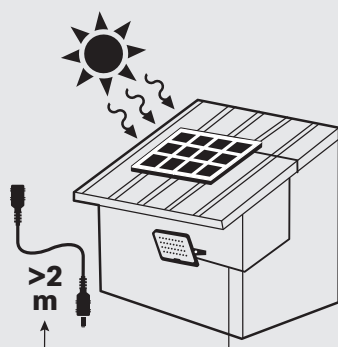

4m male/ female cable for Led Solar Floodlight (not included)

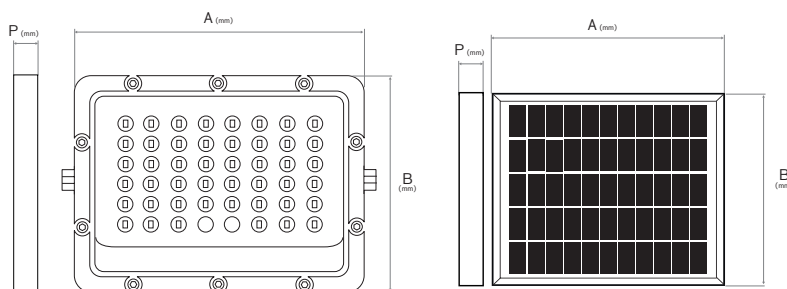

REF ^a	Length (M)	EAN code.
ASC4PLSCR	4	5604612721053



LED SOLAR FLOODLIGHT WITH REMOTE CONTROL

REF ^a	W	K	Cable for connection to solar panel	AxBxP (Solar panel) AxBxP (Floodlight)			EAN code.
ASPLSCR5060	50	600	2m	Solar panel: 220x180x10mm Floodlight: 160x120x100mm	1	10	5604612721046

LED SOLAR LIGHT

50
W

LED
SMD
2835

6000K
COOL
WHITE



CRI
≥70

IP
65

IK
10

-10°~+50°C

ALUM
DIE
CASTING

OPTICAL
LENS

6
W

MONO
CRYSTALLINE
SILICON

2
m

BATTERY

3.2
V
5000mAh



5-8h

12-15h

2000
CYCLES
X

REMOTE CONTROL



3H | 5H | 8H
TIMING
FUNCTION

AUTO

RoHS



Aslo

Waterproof Junction Boxes IP65/66



Glow-wire test 650°C

REF.	DESCRIPTION		EAN CODE
ASCDE044CZ	IP65 IK07 80x44x35mm	8	5604612717926
ASCDE090CZ	IP65 IK07 90x90x55mm	7	5604612717919
ASCDE115CZ	IP66 IK07 115x115x60mm	6	5604612717933
ASCDE150CZ	IP66 IK07 150x115x70mm	1	5604612717940
ASCDE2001CZ	IP66 IK07 200x150x80mm	1	5604612725884
ASCDE200CZ	IP66 IK07 200x150x80mm	1	5604612717957
ASCDE250CZ	IP66 IK07 200x150x125mm	1	5604612725860
ASCDE250MCZ	IP66 IK07 250x200x140mm	1	5604612725877

Aslo

WALL LED SOLAR LIGHT



BRIGHTER LIFE



WALL LED SOLAR LIGHT



The 6W LED Solar Wall Light with a modern, minimalist and concise design is perfect for creating a pleasant and decorative environment with a soft, comfortable and natural lighting effect.

Easy to install, this wall light is suitable for outdoor use, and can be used in driveways, car parks, gates, terraces, terraces, facades, fences, balconies, patios, pergolas, among others.

High luminous flux (135Lm/W), distributing an ultra-bright uniform light in a lighting area of 40 m².

In addition, it has high quality lenses that allow a 140*70° polarized light, reaching a larger area and a more comfortable illumination without glare.

Resistant housing made of high-end ABS+PC material, protected from ultraviolet rays, fire, water and dust proof with IP65 rating.

It includes a high-capacity battery with overcharge and discharge protection and a monocrystalline solar panel with high conversion and fast charging glass.

An environmentally friendly solution, with ON/OFF switch and a motion sensor for better energy management, allowing longer use.

Main features:

- High luminous flux (135Lm/W)
- High-quality reflective lenses: no glare = natural, comfortable lighting
- 2 operating modes, applicable to different circumstances
- Monocrystalline panel with tempered glass for high performance: increased durability and fast charging
- Replaceable high-capacity battery (Lithium Ion 3.7V - 3000mAh) with overload protection
- Infrared motion sensor for a better autonomy management
- Resistant ABS + PC housing, with UV rays' protection and fire resistant - VO



REF ^a	W	LM	K	A x B x C			wwEAN.
ASWALL660B	6	800	6000	230 x 97 x 42.70 mm	1	24	5604612722913
ASWALL660P	6	800	6000	230 x 97 x 42.70 mm	1	24	5604612722920

LED SOLAR LIGHT

6 W	6000 K COOL WHITE	LED SMD 2835 35um.	800 LUMENS	IP 65	-20°/+50°C	ABS + PC	ANTI UV	FIRE-PROOF	RoHS CE
SENSOR			BATTERY				SOLAR PANEL		
							MONO CRYSTALLINE SILICON	2,8 W	5,5V DC
						<small>AUTONOMY ON FULL CHARGE MODE A: 4 NIGHTS (SENSOR MODE LIGHTING) MODE B: 2 NIGHTS (CONSTANT MODE LIGHTING)</small>			

Aslo Electric

NEW EXTENSION CORDS



POWER ON

aslo.pt





EXTENSION CORD ECO

WITH/WITHOUT
SWITCH



Ref	Designation	Cable length			EAN Code
ASET3115E	3-Way Extension Cord Eco 3g 1.0mm ²	1.5m		1 30	5604612720223
ASET13115E	3-Way Extension Cord Eco 3G 1.0mm ²	1.5m	⏻	1 30	5604612720230
ASES13115E	6-Way Extension Cord Eco 3G 1.0mm ²	1.5m	⏻	1 20	5604612720247



3-GANG EXTENSION CORD WITH CABLE

AND SWITCH

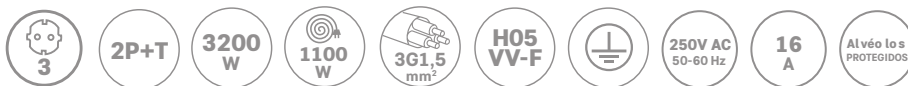

Ref	Designation	Cable length			EAN Code
ASBT3I31515	3x2P+E Extension Cord 3G 1.5mm ²	1.5m	⏻	1 30	5604612720308
ASBT3I3153	3x2P+E Extension Cord 3G 1.5mm ²	3m	⏻	1 30	5604612720315
ASBT3I3155	3x2P+E Extension Cord 3G 1.5mm ²	5m	⏻	1 20	5604612720322



4-GANG EXTENSION CORD WITH CABLE AND SWITCH



Ref	Designation	Cable length			EAN Code
ASBQ4I31515	4x2P+E Extension Cord 3G1.5mm ²	1.5m		30	1 5604612720339
ASBQ4I3153	4x2P+E Extension Cord 3G1.5mm ²	3m		30	1 5604612720346
ASBQ4I3155	4x2P+E Extension Cord 3G1.5mm ²	5m		20	1 5604612720353



6-GANG EXTENSION CORD WITH CABLE AND SWITCH

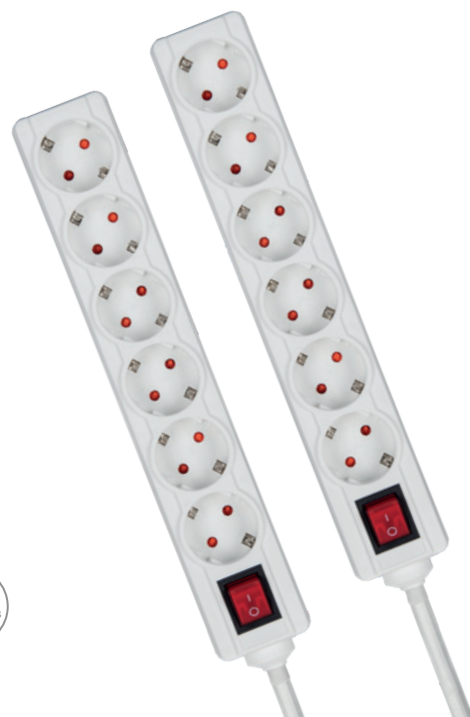

Ref	Designation	Cable length			EAN Code
ASBS6I31515	4x2P+E Extension Cord 3G1.5mm ²	1.5m		20	1 5604612720360
ASBS6I3153	4x2P+E Extension Cord 3G1.5mm ²	3m		20	1 5604612720377
ASBS6I3155	4x2P+E Extension Cord 3G1.5mm ²	5m		20	1 5604612720384

Aslo Electric

CABLE REEL ECO

- Thermal protection
- Child protection
- Overheating protection of the reel
- Structure: strong and stable galvanised steel tube
- Easy transport thanks to the ergonomic handle



Ref.	Dim.		EAN code
ASENR31525E	25 m	1	5604612720254
ASENR31550E	50 m	1	5604612720261

Aslo

BRIGHTER LIFE



RING SERIES

**ROUND OUTDOOR WATERPROOF
LED BULKHEAD LIGHT**

OUTDOOR LIGHTING



The new Ring Range features LED wall bulkhead lights which present a modern design and are ideal for lighting outdoor spaces such as public entrances, walls, façades, stairs, corridors and passageways. These models made of ABS plastic and Polycarbonate guarantee a long durability and have an IP54 rating, providing protection from dust and water. Through its opaline diffuser, they ensure even luminosity,

avoiding glare and disturbing light reflections. The version of the LED model with motion sensor provides greater consumption savings, safety and convenience, and is suitable for passageway areas. In addition, the sensor reacts not only to people's movements, but also to the brightness of the sunlight, avoiding unnecessary consumption.

ROUND OUTDOOR LED BULKHEAD LIGHT

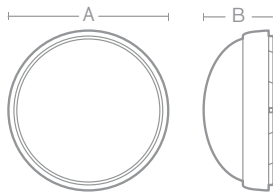

REF.	COLOUR	W	K	Lm	AxB		EAN.
ASRING840B		8	4000	600	170x57mm	16	5604612715779
ASRING840P							5604612715786
ASRING1540B		15	4000	1300	260x84mm	16	5604612715793
ASRING1540P							5604612715809

Technical data:

Use:	Outdoor
LED chip:	SMD 2835
Power supply:	220-240V AC
Beam angle:	120°
Dimmable:	No
Lifespan:	30.000h
ON/OFF switching cycles:	15.000
Colour rendering index:	> 80
Displacement factor:	0.7
IP code:	IP54
Insulation class:	II
Energy efficiency class:	
Product material:	> Frame – ABS > Diffuser – Polycarbonate > Base – Polypropylene
Standards:	RoHS / CE

ROUND OUTDOOR LED BULKHEAD LIGHT

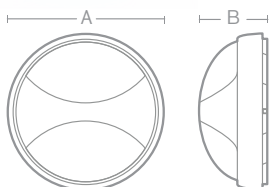

REF	COLOUR	W	K	Lm	AxB		EAN.
ASRING1540GB		15	4000	750	260x90mm	16	5604612715816
ASRING1540GP							5604612715823

Technical data:

Use:	Outdoor
LED chip:	SMD 2835
Power supply:	220-240V AC
Beam angle:	120°
Dimmable:	No
Lifespan:	30.000h
ON/OFF switching cycles:	15.000
Colour rendering index:	> 80
Displacement factor:	0.7
IP code:	IP54
Insulation class:	II
Energy efficiency class:	
Product material:	> Frame – ABS > Diffuser – Polycarbonate > Base – Polypropylene
Standards:	RoHS / CE



ROUND LED BULKHEAD LIGHT WITH MOTION SENSOR



Technical data:

Use:	Outdoor
LED chip:	SMD 2835
Power supply:	220-240V AC
Beam angle:	120°
Dimmable:	No
Lifespan:	30.000h
ON/OFF switching cycles:	15.000
Colour rendering index:	> 80
Displacement factor:	0.7
Output current:	51mA
IP code:	IP54
Insulation class:	II
Energy efficiency class:	
Product material:	> Frame – ABS > Diffuser – Polycarbonate > Base - Polypropylene
Standards:	RoHS / CE

Sensor characteristics:

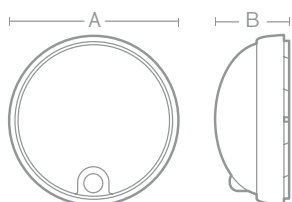
Ambient light:	<15 LUX
Power:	0,4W
Detection angle:	100°
Installation height:	1~2,5m
Detection area:	8m
Timing:	60±10sec
Detection speed :	0,8~1,5m/s
Operating temperature:	-20°~+40°C
Relative working humidity:	<93% RH



REF	COLOUR	W	K	Lm	AxB		EAN.
ASRINGS1540B		15	4000	1300	260x84mm	16	5604612715830
ASRINGS1540P							5604612715847

DETECTION AREA

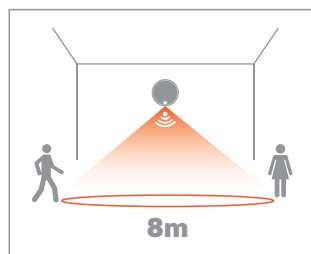

INSTALLATION HEIGHT

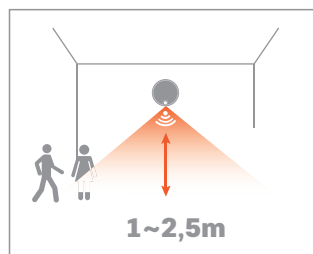

TIMING

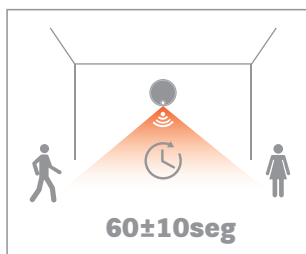

DETECTION SPEED

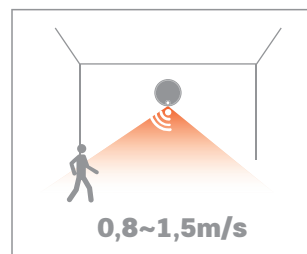



Features	ASRING840B ASRING840P	ASRING1540B ASRING1540P	ASRING1540GB ASRING1540GP	ASRINGS1540B ASRINGS1540P
Power:	8W	15W	15W	15W
Lumens:	600lm	1300lm	750lm	1300lm
Color temperature:	4000K	4000K	4000K	4000K
Chip led:	SMD 2835	SMD 2835	SMD 2835	SMD 2835
Power supply:	220-240V AC	220-240V AC	220-240V AC	220-240V AC
Colours				
With sensor:	-	-	-	Sim
Beam angle:	120°	120°	120°	120°
Dimmable:	-	-	-	-
Lifespan:	30.000h	30.000h	30.000h	30.000h
ON/OFF switching cycles:	15.000	15.000	15.000	15.000
Colour rendering index:	CRI 80	CRI>80	CRI>80	CRI>80
Output current:	28mA	51mA	51mA	51mA
IP code:	IP54	IP54	IP54	IP54
Insulation class:				
Energy efficiency class				
Dimensions:	170x57mm	260x84mm	260x90mm	260x84mm
Weight:	280g	500g	537g	530g
Packaging dimensions:	174x64x174mm	264x264x94mm	264x264x94mm	264x264x94mm
Weight with packaging:	300g	632g	670g	663g



Aslo

PHAROS SÉRIES

**SURFACE-MOUNTED
LED ROUND/SQUARE
DOWNLIGHT**

INDOOR LIGHTING



PHAROS SÉRIES



SUFACE-MOUNTED LED ROUND DOWNLIGHT



SURFACE-MOUNTED LED SQUARE DOWNLIGHT



Technical data:

Use:	Indoor
LED chip	Citizen COB
Voltage:	220-240V AC
Beam angle:	60°
Dimmable:	No
Lifespan:	50,000 h
Displacement factor:	0.9
Output current:	230 mA
IP code:	IP54 (LED cap)
IP code:	IP20 (Other parts)
Mechanical impact resistance rating:	IK06
Insulation class:	I
Energy efficiency class:	A
Material:	> Aluminium > Polycarbonate > Curved lenses
Standards:	RoHS / CE

ASLO's new surface-mount downlights features a Citizen COB LED and have a high transmittance curved lens with a 60° beam angle.

The ADC12 heatsink (aluminium die cast alloy) and multi-layer structure provide excellent heat dissipation. The adjustable light direction - 360° horizontal and 23° vertical - offers all possible lighting effects.

Features:

- Adjustable light direction. 360° horizontally and 23° vertically.
- High luminous efficacy, 100lm/W.
- Finish colour: White/Black
- High Transmittance Curved Lens
- Quick connection terminal for easy installation.
- Built-in driver.

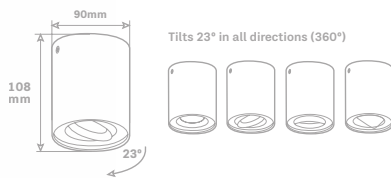

REF.	COLOR	W	K	CRI	Lm	AxB			EAN code
ASPHR827BR		10	2700	82	940	108x90mm	1	24	5604612718152
ASPHR827PR		10	2700	82	940	108x90mm	1	24	5604612718121
ASPHR840BR		10	4000	84	1080	108x90mm	1	24	5604612718145
ASPHR840PR		10	4000	84	1080	108x90mm	1	24	5604612718138

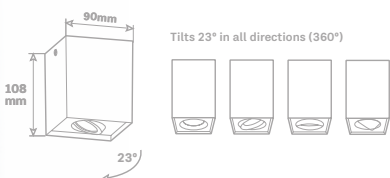

REF.	COLOR	W	K	CRI	Lm	AxB			EAN code
ASPHQ827BR		10	2700	82	940	108x90mm	1	24	5604612718169
ASPHQ827PR		10	2700	82	940	108x90mm	1	24	5604612718190
ASPHQ840BR		10	4000	84	1080	108x90mm	1	24	5604612718176
ASPHQ840PR		10	4000	84	1080	108x90mm	1	24	5604612718183



ASPHR827BR
ASPHR827PR
ASPHQ827BR
ASPHQ827PR

ASPHR840BR
ASPHR840PR
ASPHQ840BR
ASPHQ840PR

Technical data:

Power:	10W	10W
Lumens:	940lm	1080lm
Colour temperature:	2700K	4000K
LED chip	CITIZEN COB	CITIZEN COB
Voltage:	200-240V AC	200-240V AC
Colours:		
With motion detector:	-	-
Beam angle:	60°	60°
Dimmable:	-	-
Lifespan:	50.000h	50.000h
Colour rendering index:	CRI 82	CRI 84
Output current:	230mA	230mA
IP code:	IP54 (LED cap)	IP54 (LED cap)
IP code:	IP20 (Other parts)	IP20 (Other parts)
Insulation class:		
Energy efficiency class:		
Dimension	108x90mm	108x90mm
Packaging dimension:	130 x 122 x 122 mm	130 x 122 x 122 mm

Aslo

HOME

DUSTPROOF ACRYLIC FIXTURE WITH PC DIFFUSER

LED
hi-tech

EMPTY



WIRING DIAGRAM – TYPE:
CONNECTION IN ONE END ONLY



REF.		DIM.			EAN CODE
ASAA02060V		600mm	1	8	5604612719739
ASAA02120V	2xG13	1200mm	1	8	5604612719746
ASAA02150V		1500mm	1	8	5604612719753

Aslo

BRIGHTER LIFE

STREET LIGHTS

OUTDOOR LIGHTING



URBANLED
SERIES

The ASLO's new URBANLED street lights are the ideal solution for public lighting, presenting themselves as an alternative to conventional lighting due to their high efficiency, perfect light distribution and better colour rendering index. In addition to the substantial reduction in energy consumption and the low environmental impact, they offer a high quality of light output.



130X60°
OPTICAL LENS
IN POLYCARBONATE



URBAN ECO

A street light that can be adapted to various applications, meeting different installation requirements in different locations

ECO LED STREET LIGHT

Technical data:

Use:	Exterior
LED chip:	SMD 2835
Driver:	DOB
Voltage:	220-240V AC
Beam angle:	130x60°
Dimmable:	No
Service life:	36.000h
ON/OFF switching cycles:	15.000
Colour rendering index:	80
Displacement factor:	0.9
Insulation class:	
IP code:	IP65
Mechanical impact resistance:	IK08
Energy efficiency class:	
Product material:	> Aluminio > Polycarbonate
Standards:	RoHS / CE

SURGE PROTECTION:
3kV

LUMINOUS EFFICACY:
120LM/W

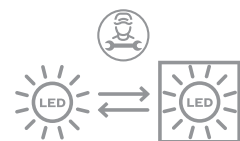
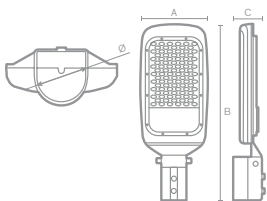

REF ^a	W	K	USEFUL LUMENS (120°)	TOTAL LUMENS	A	AxBxC	Ø		EAN.
ASURBE7050	70	5000	7000 (100LM/W)	8400 (120LM/W)	0,35	140x390x80mm	62mm	10	5604612720209
ASURBE10050	100		10000 (100LM/W)	12000 (120LM/W)	0,5	190x465x80mm			5604612720193



URBANLED
SERIES

URBAN SLIM

Street light with optical lenses in Polycarbonate that provide the perfect balance for a discreet application, through its ultra-thin design, with high luminous efficiency and visual comfort.

SLIM LED STREET LIGHT

Technical data:

Use:	Exterior
LED chip:	SMD 2835
Driver:	Externo
Voltage:	100-240V AC
Beam angle:	130x60°
Dimmable:	No
Service life:	54.000h
ON/OFF switching cycles:	15.000
Colour rendering index:	80
Displacement factor:	0.9
Insulation class:	
IP code:	IP65
Mechanical impact resistance:	IK08
Energy efficiency class:	
Product material:	> Aluminio > Polycarbonate
Standards:	RoHS / CE

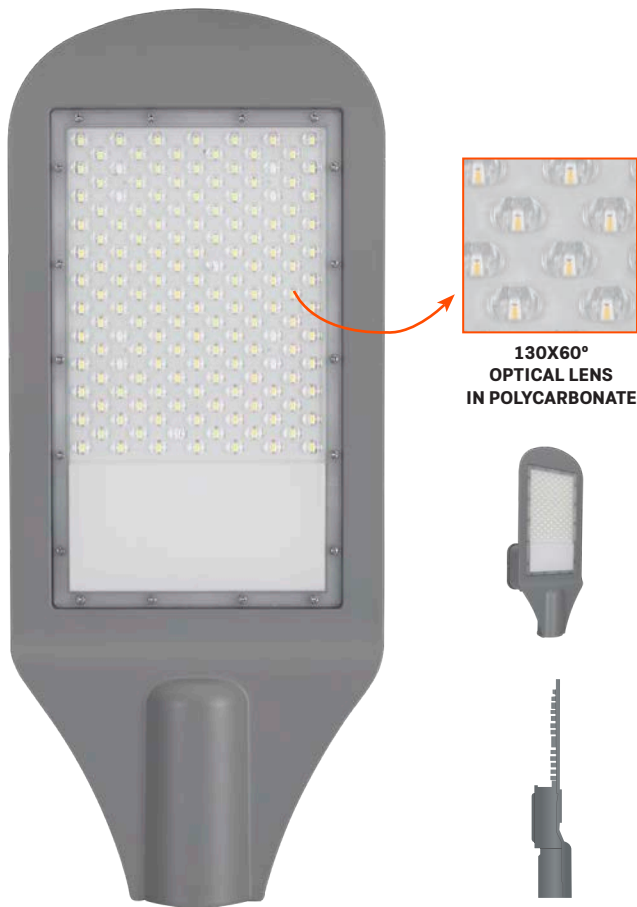

130X60°
OPTICAL LENS
IN POLYCARBONATE



SURGE PROTECTION:
6kV

LUMINOUS EFFICACY:
150LM /W

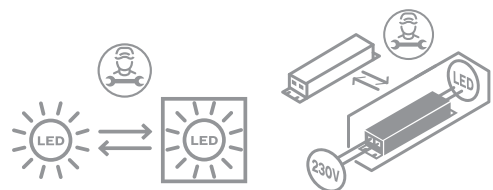
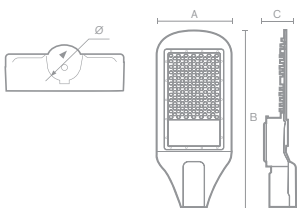

REF ^a	W	K	USEFUL LUMENS (120°)	TOTAL LUMENS	A	AxBxC	Ø		EAN.
ASURBS10050	100	5000	12500 (125LM/W)	15000 (150LM/W)	0,5	210x493x89mm	61mm	10	5604612720179
ASURBS15050	150		18700 (125LM/W)	22500 (150LM/W)	0,75	240x595x89mm			

URBAN ECO



URBAN SLIM



Technical data	ASURBE7050	ASURBE10050	ASURBS10050	ASURBS15050
Power:	70W	100W	100W	150W
Useful lumens (120°):	7000 LM	10000 LM	12500 LM	18700 LM
Total lumens:	8400 LM	12000 LM	15000 LM	22500 LM
Colour temperaturer:	5000K	5000K	5000K	5000K
LED chip :	SMD 2835	SMD 2835	SMD 2835	SMD 2835
Voltage:	220-240V AC	220-240V AC	100-240V AC	100-240V AC
Driver:	DOB	DOB	External	External
Colour:				
With sensor:	No	No	No	No
Beam angle:	130x60°	130x60°	130x60°	130x60°
Dimmable:	No	No	No	No
Service life:	36.000h	36.000h	54.000h	54.000h
ON/OFF switching cycles:	15.000	15.000	15.000	15.000
Colour rendering index:	CRI80	CRI80	CRI80	CRI80
Surge protection:	3kV	3kV	6kV	6kV
Input current:	0,35A	0,5A	0,5A	0,75A
IP code:	IP65	IP65	IP65	IP65
Mechanical impact resistance rating:	IK08	IK08	IK08	IK08
Insulation class:				
Energy efficiency class:				
Product dimensions:	140x390x80mm	190x465x80mm	210x493x89mm	240x595x89mm
Packaging dimensions:	143x393x72mm	195x470x72mm	507x230x90mm	607x260x90mm

Aslo

BRIGHTER LIFE

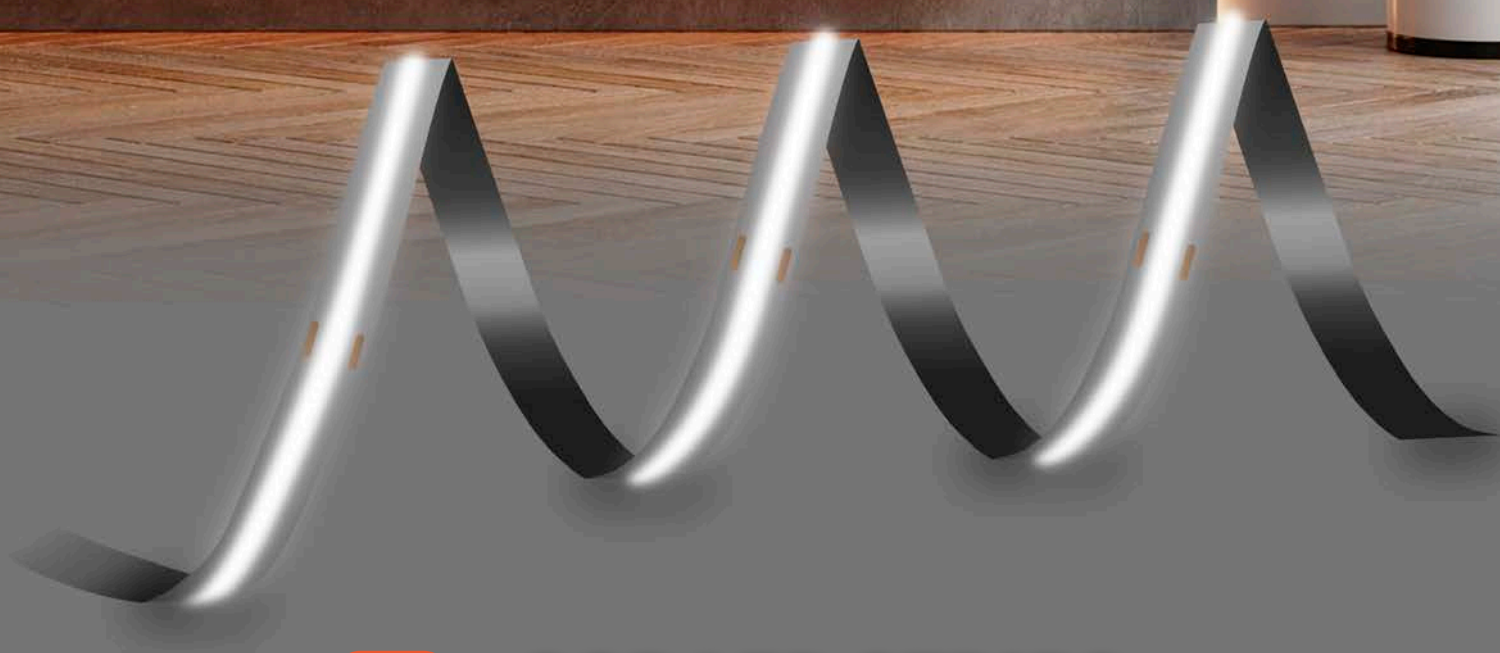

COB LED STRIPS
INDOOR LIGHTING

The new range of COB LED strips from ASLO, are the perfect solution to achieve perfect, uniform lighting with no visible dots or shadows.

COB technology has emerged as a cutting-edge, encompassing and attractive solution.

It has been developed to visually eliminate light dots, creating a continuous and uniform line of light with high flux over the entire length.

No light dots are visible, unlike with conventional LED strips.

HIGH COLOUR RENDERING INDEX: 10W = CRI >80
12W = CRI >90

EXCELLENT UNIFORMITY OF LIGHT, NO DOTS! 10W = 384 Leds/m
12W = 700 Leds/m



10W



12W

Advantages of ASLO's COB LED strips:

- Homogenous and continuous light without dots;
- Variety of colour temperatures (2700K, 4000K and 6500K);
- Easy to apply, thanks to their flexibility and divisibility (cuts every 4cm - 10W and cuts every 1cm - 12W);

- A wider universe of applications;
- Excellent heat dissipation (high quality double layer PCB);
- Larger beam angle;
- Easy mounting on any surface, via the self-adhesive strip on the back of the LED strip;

Main application areas:

- General lighting - indirect light mouldings;
- Shops, bars, hotels and restaurants.
- Offices;
- Houses.



Technical data:

Use:	Indoor	Dimmable:	Yes
PCB:	10mm	IP code:	IP20
Voltage:	24V	Energy efficiency class:	A G F
Operating temperature:	-25°-60°C	Standards:	RoHS / CE
Insulation class:			



COB LED STRIP

Ref.	Packaging	DIM.	W /m	W /0,5m	Leds /m	USEFUL LUMENS		K	CRI			EAN CODE
						Lm/m	Lm/0,5m					
ASFLCOB241027		5m	10	5	384	1000 ^(360°)	500 ^(360°)	2700				5604612716240
ASFLCOB241040						1100 ^(360°)	550 ^(360°)	4000	>80	1	50	5604612716189
ASFLCOB241065						1100 ^(360°)	550 ^(360°)	6500				5604612716196
ASFLCOB241227		5m	12	6	700	1200 ^(360°)	600 ^(360°)	2700				5604612716257
ASFLCOB241240						1300 ^(360°)	650 ^(360°)	4000	>90	1	50	5604612716219
ASFLCOB241265						1300 ^(360°)	650 ^(360°)	6500				5604612716202

- Easy to apply, thanks to their flexibility and divisibility (cuts every 4cm - 10W and cuts every 1cm - 12W);
- High quality double layer PCB.

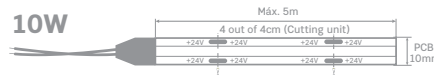

Accessories available for strip installation:

- Power supplies, connectors and aluminium profiles for various mounting options.

COB LED STRIP CONNECTOR



REF ^a		EAN CODE
ASFCFCOB10	25	5604612716226

COB LED STRIP CABLE CONNECTOR



REF ^a		EAN CODE
ASCCFCOB10	25	5604612716233

Aslo

BRIGHTER LIFE



RING SERIES

**ROUND OUTDOOR WATERPROOF
LED BULKHEAD LIGHT**

OUTDOOR LIGHTING



The new Ring Range features LED wall bulkhead lights which present a modern design and are ideal for lighting outdoor spaces such as public entrances, walls, façades, stairs, corridors and passageways. These models made of ABS plastic and Polycarbonate guarantee a long durability and have an IP54 rating, providing protection from dust and water. Through its opaline diffuser, they ensure even luminosity,

avoiding glare and disturbing light reflections. The version of the LED model with motion sensor provides greater consumption savings, safety and convenience, and is suitable for passageway areas. In addition, the sensor reacts not only to people's movements, but also to the brightness of the sunlight, avoiding unnecessary consumption.

ROUND OUTDOOR LED BULKHEAD LIGHT

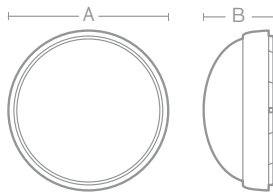





REF	COLOUR	W	K	Lm	AxB		EAN.
ASRING1540B		15	4000	1300	260x84mm	16	5604612715793
ASRING1540P							5604612715809

Technical data:

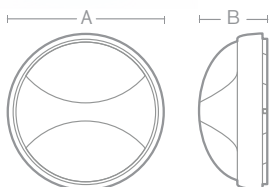
Use:	Outdoor
LED chip:	SMD 2835
Power supply:	220-240V AC
Beam angle:	120°
Dimmable:	No
Lifespan:	30.000h
ON/OFF switching cycles:	15.000
Colour rendering index:	> 80
Displacement factor:	0.7
IP code:	IP54
Insulation class:	II
Energy efficiency class:	
Product material:	> Frame – ABS > Diffuser – Polycarbonate > Base – Polypropylene
Standards:	RoHS / CE

ROUND OUTDOOR LED BULKHEAD LIGHT



REF	COLOUR	W	K	Lm	AxB		EAN.
ASRING1540GB		15	4000	750	260x90mm	16	5604612715816
ASRING1540GP							5604612715823

Technical data:

Use:	Outdoor
LED chip:	SMD 2835
Power supply:	220-240V AC
Beam angle:	120°
Dimmable:	No
Lifespan:	30.000h
ON/OFF switching cycles:	15.000
Colour rendering index:	> 80
Displacement factor:	0.7
IP code:	IP54
Insulation class:	II
Energy efficiency class:	
Product material:	> Frame – ABS > Diffuser – Polycarbonate > Base – Polypropylene
Standards:	RoHS / CE



ROUND LED BULKHEAD LIGHT WITH MOTION SENSOR

Technical data:

Use:	Outdoor
LED chip:	SMD 2835
Power supply:	220-240V AC
Beam angle:	120°
Dimmable:	No
Lifespan:	30.000h
ON/OFF switching cycles:	15.000
Colour rendering index:	> 80
Displacement factor:	0.7
Output current:	51mA
IP code:	IP54
Insulation class:	II
Energy efficiency class:	F
Product material:	> Frame – ABS > Diffuser – Polycarbonate > Base - Polypropylene
Standards:	RoHS / CE

Sensor characteristics:

Ambient light:	<15 LUX
Power:	0,4W
Detection angle:	100°
Installation height:	1~2,5m
Detection area:	8m
Timing:	60±10sec
Detection speed :	0,8~1,5m/s
Operating temperature:	-20°~+40°C
Relative working humidity:	<93% RH

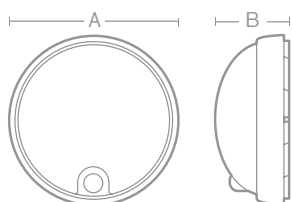

REF	COLOUR	W	K	Lm	AxB		EAN.
ASRINGS1540B		15	4000	1300	260x84mm	16	5604612715830
ASRINGS1540P							5604612715847

DETECTION AREA

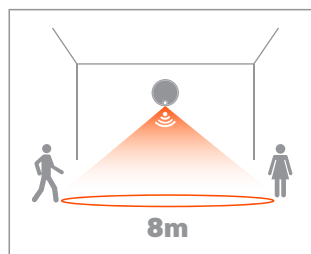

INSTALLATION HEIGHT

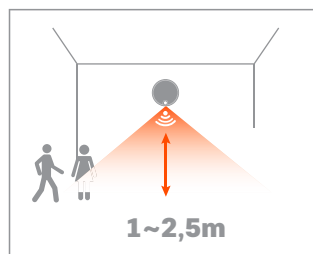

TIMING

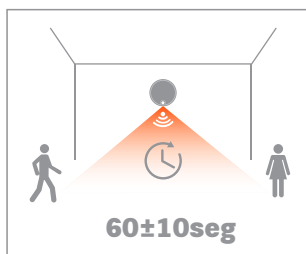

DETECTION SPEED

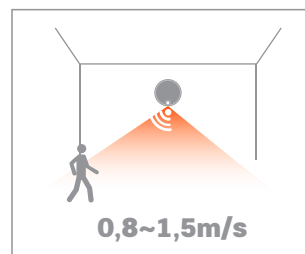



Features	ASRING1540B ASRING1540P	ASRING1540GB ASRING1540GP	ASRINGS1540B ASRINGS1540P
Power:	15W	15W	15W
Lumens:	1300lm	750lm	1300lm
Color temperature:	4000K	4000K	4000K
Chip led:	SMD 2835	SMD 2835	SMD 2835
Power supply:	220-240V AC	220-240V AC	220-240V AC
Colours			
With sensor:	-	-	Sim
Beam angle:	120°	120°	120°
Dimmable:	-	-	-
Lifespan:	30.000h	30.000h	30.000h
ON/OFF switching cycles:	15.000	15.000	15.000
Colour rendering index:	CRI>80	CRI>80	CRI>80
Output current:	51mA	51mA	51mA
IP code:	IP54	IP54	IP54
Insulation class:			
Energy efficiency class			
Dimensions:	260x84mm	260x90mm	260x84mm
Weight:	500g	537g	530g
Packaging dimensions:	264x264x94mm	264x264x94mm	264x264x94mm
Weight with packaging:	632g	670g	663g

Aslo

DROP SERIES

OVAL LED BULKHEAD LIGHT

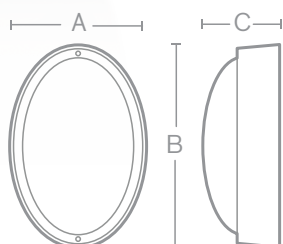

Technical data:

Use:	Outdoor
Chip led:	SMD 2835
Power supply:	220-240V AC
Beam angle:	120°
Dimmable:	Não
Lifespan:	30.000h
ON/OFF switching cycles:	15.000
Colour rendering index:	> 80
Displacement factor:	0.7
Output current:	50mA
IP code:	IP65
Insulation class:	II
Energy efficiency class:	F
Dimensions:	164(A)x240(B)x78(C)mm
Weight:	0,335kg
Packaging dimensions:	166x81x243mm
Weight with packaging:	0,365kg
Product material:	> Frame – ABS > Diffuser – Polycarbonate > Base - Polypropylene
Standards:	RoHS / CE

REF	W	K	Lm		EAN.
ASDROP1540B	15	4000	1050	20	5604612715854

ASLO Power Supplies are ideal for the connection of lighting systems that cannot be directly connected to the mains (230V), such as LED strips and other devices that require a continuous supply - DC12V / DC24V .

They have a reduced "SLIM" size, which makes them easy to install in any space, when the situation requires it, without being visible.



Main features:

- > Perforated plate structure that allows cooling;
- > Small sized;
- > The output voltage can be adjusted $\pm 10\%$, compensating for the voltage drop between the power supply and the point of consumption.
- > It features overload and overvoltage protection



POWER SUPPLY SLIM – 12V

REF ^a	W	A	INPUT	OUTPUT	DIM.		EAN.
ASFAS1260	60	5			160x40x32mm	1	5604612716035
ASFAS12100	100	8,5			188x47x38mm	1	5604612716066
ASFAS12150	150	12,5	110-220V AC	12V DC	200x58x39mm	1	5604612716073
ASFAS12200	200	16,5			223x68x40mm	1	5604612716103
ASFAS12250	250	20,8			223x68x40mm	1	5604612716110

Remark: These power supplies are suitable for ASLO's Range of 12V SMD LED Strip Light.



FONTES DE ALIMENTAÇÃO SLIM - 24V

REF ^a	W	A	INPUT	OUTPUT	DIM.		EAN.
ASFAS2460	60	2,5			160x40x32mm	1	5604612716042
ASFAS24100	100	4,25			188x47x38mm	1	5604612716059
ASFAS24150	150	6,25	110-220V AC	24V DC	200x58x39mm	1	5604612716080
ASFAS24200	200	8,25			223x68x40mm	1	5604612716097
ASFAS24250	250	10,4			223x68x40mm	1	5604612716134

Remark: These power supplies are suitable for ASLO's Range of 24V SMD LED Strip Light.

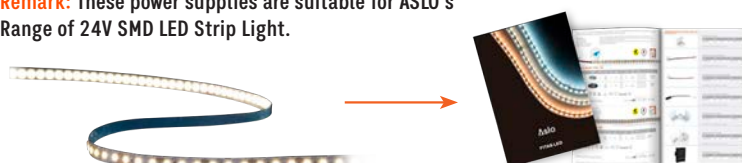



POWER SUPPLY SLIM – 12V

REF ^a	W	A	INPUT	OUTPUT	DIM.		EAN.
ASTFLS1224	24	2	110-240V AC	12V DC	160mm	1	5604612716165
ASTFLS1236	36	3					5604612716172

RoHS 

Remark: These power supplies are suitable for ASLO's Range of 12V SMD LED Strip Light.



ACCESSORIES FOR LED STRIPS



LED STRIP SILICON END CAP

Main features:

- > Material: Silicone
- > Finish: transparent;
- > Easy application;
- > Provides maximum waterproofness to the LED strip.

REF ^a	DIM.		EAN.
ASTSFL812	8mm	25*	5604612716264
ASTSFL1024	10mm	25*	5604612716271

*Minimum sale quantity 25 pcs. - 1 bag.

RoHS 

Remark: These silicone end caps are suitable for IP65 | 12VDC (8mm PCB) and 24VDC (10mm PCB) SMD LED strips.



Aslo

BRIGHTER LIFE

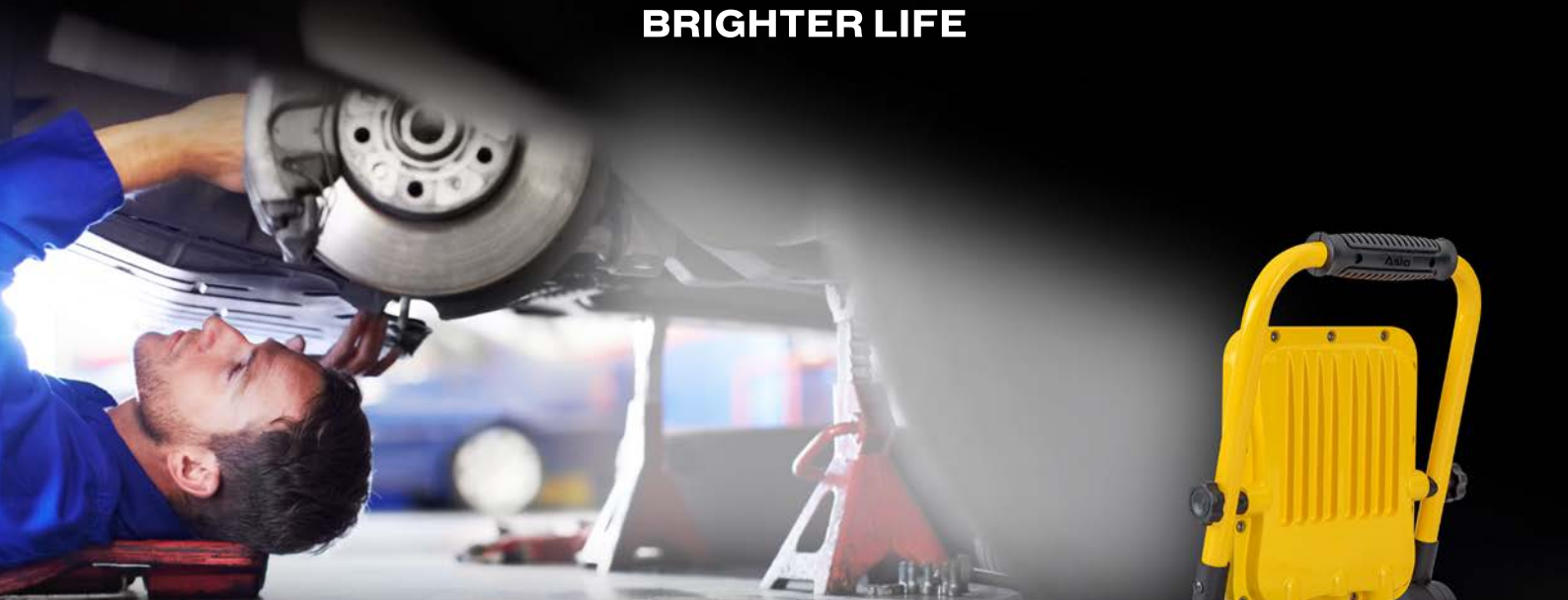

WORK SERIES



Rechargeable worklight 3 levels of intensity

Portable lighting - Indoor/Outdoor

aslo.pt



Watch video

Aslo

BRIGHTER LIFE



Rechargeable worklight 3 levels of intensity

Technical data:

Led SMD 2835 Lumileds:	30W 50W
Colour temperature:	6000K
Lumens:	1200 Lm 1800 Lm
Running time:	4~12h
Charging time:	30W - 2h 50W - 3,5h
Battery:	Lithium-ion - 21700
Supply voltage:	30W - 3,7V 5.000 mAh 50W - 3,7 V 10.000 mAh
Beam angle:	90°
Rotation:	360°
Lighting modes:	3 modes: 4h - Max. brightness 100% 9h - Max. brightness 60% 12h - Max. brightness 20%
IP code:	IP65
Impact protection rating:	IK08
Insulation class:	III
Parts material:	> Aluminium housing > Polycarbonate lens

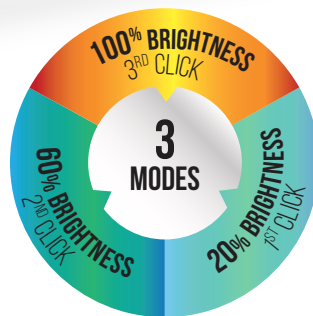

REF ^a	W	K	Lm	A x B x C		EAN CODE
ASWORK3060	30	6000	1200	217,5x279,8x56,6mm	10	5604612712693
ASWORK5060	50		1800	244,5x324x59,4mm	10	5604612712709



CRI >80

3 FUNCTIONS

IP 65

IK08



ALUM

PC

RoHS

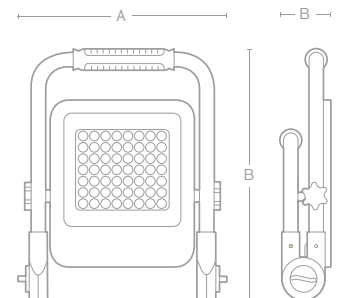

> Operation - Intensity setting/ running time



1 click - If you press the ON /OFF push button once, you get 20% intensity.



2 clicks - If you press the ON /OFF push button twice, you get 60% intensity.



3 clicks - If you press the ON /OFF push button three times, you get 100% intensity.



MAXIMUM BRIGHTNESS OF
20%
[Battery icon] - 12 HRS

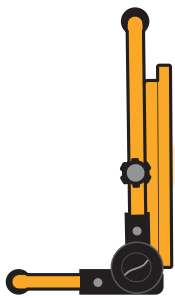

MAXIMUM BRIGHTNESS OF
60%
[Battery icon] - 9 HRS

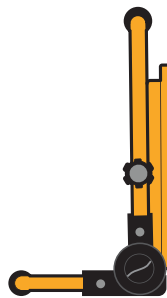

MAXIMUM BRIGHTNESS OF
100%
[Battery icon] - 4 HRS

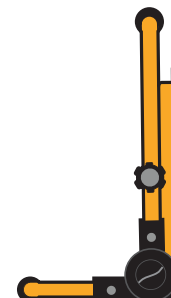

Remark: The worklight features memory function which allows it to return to previous setting when turned on again.

> Easy adjustment

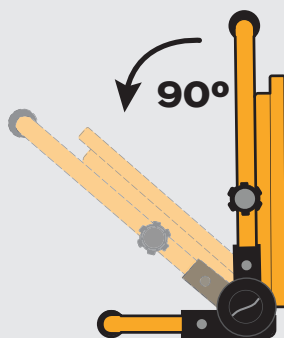
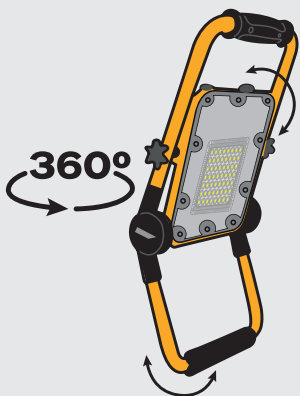

> Charging:

The device is charged using a USB cable (5V DC 2 Ah supply). The power adaptor is not included. The total charging time is 2 hours for the 30W worklight; 3.5 hours for the 50W worklight.

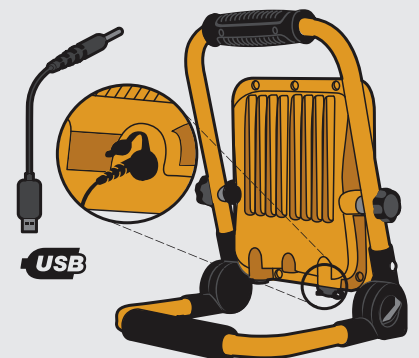

> Slim model:

Worklight with foldable support and carrying handle.

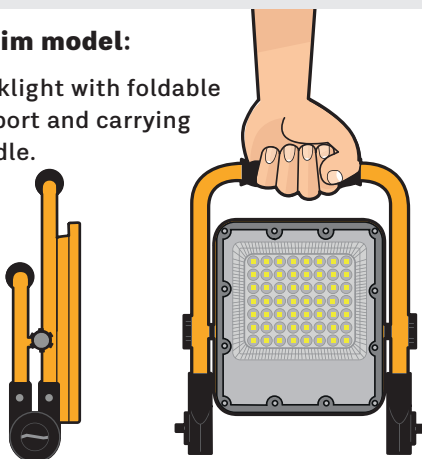

Ventilation slots provide effective heat dissipation.



To turn off the worklight, press continuously the On /Off push button for about 2sec.





Technical data

Power:	> 30W > 50W
--------	----------------

Photometric data

Colour temperature:	> 6000K
Luminous flux:	> 30W - 1200 Lm > 50W - 1800 Lm

Luminotechnical data

Beam angle:	> 90°
Beam angle adjustment:	> 360°

Materials:

Housing:	> Aluminium
Lens:	> PC – Polycarbonate

Use:

Space:	Indoor/ Outdoor
--------	-----------------

Features

Replaceable LED chip:	> No
Battery:	Lithium-ion (replaceable)

Standards and certifications

IP code:	> IP65
Impact protection rating:	> IK08
Insulation class:	> III
Standards:	> CE / RoHS

Aslo

BRIGHTER LIFE

NEW

Slim Led Floodlight

Outdoor lighting

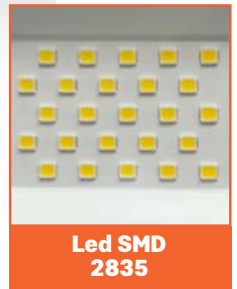

REF ^a	Colour	W	LM	Led SMD 2835	Surge	K	AxBxC			EAN.
ASLIM1050B	○	10	800	13 un.	1 Kv	5000	108x100x24mm	1	60	5604612707910
ASLIM1050P	●	10	800	13 un.	1 Kv	5000	108x100x24mm	1	60	5604612707903
ASLIM2050B	○	20	1600	25 un.	1 Kv	5000	143x130x24mm	1	40	5604612707927
ASLIM2050P	●	20	1600	25 un.	1 Kv	5000	143x130x24mm	1	40	5604612707934
ASLIM3050B	○	30	2550	36 un.	1 Kv	5000	187x167x24mm	1	30	5604612707958
ASLIM3050P	●	30	2550	36 un.	1 Kv	5000	187x167x24mm	1	30	5604612707941
ASLIM5050B	○	50	4250	54 un.	1 Kv	5000	217x185x26mm	1	20	5604612707965
ASLIM5050P	●	50	4250	54 un.	1 Kv	5000	217x185x26mm	1	20	5604612707972
ASLIM10050B	○	100	8500	108 un.	3 Kv	5000	287x240x32mm	1	10	5604612707989
ASLIM10050P	●	100	8500	108 un.	3 Kv	5000	287x240x32mm	1	10	5604612707996
NEW ASLIM15050B	○	150	13000	162 un.	3 Kv	5000	326x288x35mm	1	5	5604612714383
ASLIM15050P	●	150	13000	162 un.	3 Kv	5000	326x288x35mm	1	5	5604612714390
NEW ASLIM20050B	○	200	17000	216 un.	3 Kv	5000	382x330x35mm	1	5	5604612714406
ASLIM20050P	●	200	17000	216 un.	3 Kv	5000	382x330x35mm	1	5	5604612714413



ALUM GLASS



CRI 80

IP 65

RoHS

